



2013



# **GAVA** *plast*

**AJTÓBETÉTEK MŰANYAG ÉS ALUMÍNIUM PROFILRENDSZEREKHEZ  
DOOR-INFILL PANELS FOR ALUMINIUM & PLASTIC SYSTEMS**





***GAVA plast***

3

***GAVA aluminium***

43

***GAVA hpl***

71

***kiegészítők / accessories***

93

***technikai adatok / technical data***

97



GAVA 271  
aranytölgy/  
golden Oak

# **GAVA *plast***

**AJTÓBETÉTEK MŰANYAG ÉS ALUMÍNIUM PROFILRENDSZEREKHEZ  
DOOR-INFILL PANELS FOR ALUMINIUM & PLASTIC SYSTEMS**

2-3

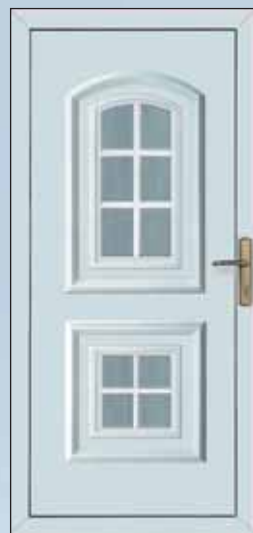

**GAVA 010,**  
16 mm-es fehér  
álosztóval/16 mm white  
lattice at



**GAVA 012**

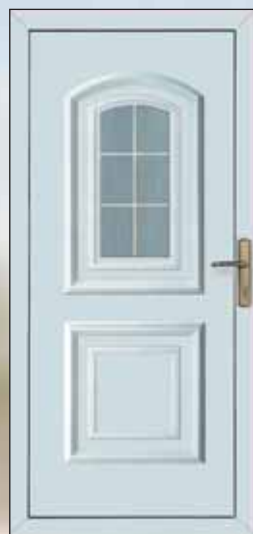

**GAVA 014,**  
8 mm-es fehér  
álosztóval/ 8 mm white  
lattice at



**GAVA 015**



**GAVA 011**

Tiffany üvegek / Tiffany glasses



**GAVA 012**  
,Arkada'



**GAVA 012**  
,Klasik'



**GAVA 012**  
,Raute'



**GAVA 012**  
,Kala'



**GAVA 012**  
,Twist'



**GAVA 012 + 012/2**  
,Abstrakt'



**GAVA 011**  
aranytölgy, golden Oak



**GAVA 014-V**  
Planibel bronz  
domborított üveggel,  
8mm-es arany színű ál-  
osztóval / embossed glass  
8 mm gold lattice at



**GAVA 015-V**  
Stopsol bronz  
domborított üveggel/  
Stopsol bronz  
embossed glass

DecorGlass üvegek / DecorGlass glasses



GAVA 012 ,Leaves'



GAVA 012  
,Light Ray'



GAVA 012  
,Karo'



GAVA 012  
,Rosa'





DecorGlass üvegek / DecorGlass glasses



**GAVA 012**  
,Royal'



**GAVA 012**  
,Tulip'



**GAVA 012**  
,Fazeta'



**GAVA 012**  
,Twist 2'



**GAVA 012**  
,Moher'

FussingGlass



**GAVA 012**  
,Hviezdny prach'

Tiffany üvegek / Tiffany glasses



**GAVA 012**  
,Kolibrík'



**GAVA 012**  
,Motýle'



**GAVA 012**  
,Volavka'



**GAVA 012**  
,Vlěie maky'



**GAVA 021**  
,Avalon'



**GAVA 020**



**GAVA 021**



**GAVA 022**  
8mm-es fehér  
áloztóval / 8mm white  
lattice at



**GAVA 023**  
aranytölgy/golden Oak  
8mm-es bronz színű ál-  
osztóval /  
8mm bronze lattice at



**GAVA 024**  
8mm-es arany színű ál-  
osztóval / 8mm gold lattice at

Tiffany üveg / Tiffany glass



**GAVA 021**  
,Volavka'



**GAVA 021**  
,Kala'



**GAVA 021**  
,Listy'



**GAVA 021**  
,Karo'



**GAVA 021**  
,Light Ray'

DecorGlass üveg / DecorGlass glass



**GAVA 021**  
mahagón,  
'Jeseò'

**GAVA 021/2**  
mahagón,  
'Jeseò'



FussingGlass



**GAVA 021**  
,Hviezdny prach'



**GAVA 021**  
,Jeseň'



**GAVA 021**  
,Vlèie maky'



**GAVA 021**  
,Trojruža'



**GAVA 030**



**GAVA 031**

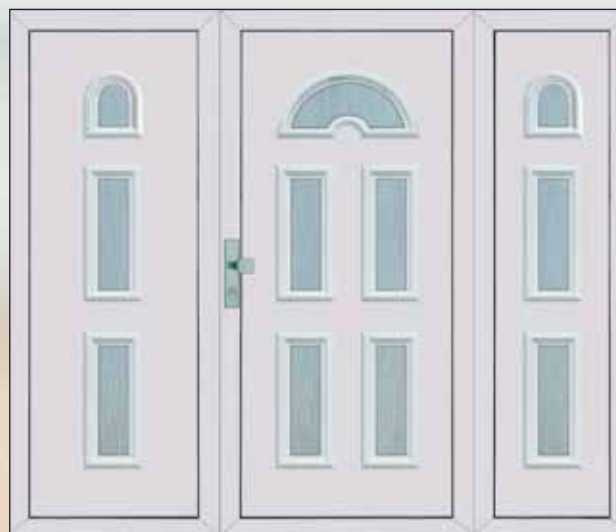

**GAVA 033/2 extra, GAVA 033, 033/2**

Domboritott üveg / Embossed glass



**GAVA 032-V**  
aranytölgy, domboritott Stopsol bronz üveg /  
golden Oak, embossed Stopsol bronz glass

DecorGlass üvegek / DecorGlass glasses



**GAVA 031**  
8mm-es fehér álosztóval /  
8mm white lattice at



**GAVA 033**

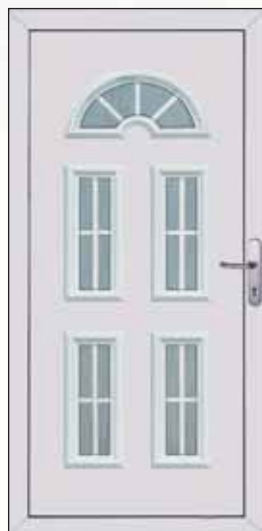

**GAVA 034**  
16mm-es fehér álosztóval /  
16mm white lattice at



**GAVA 031**  
,Maroko'



**GAVA 032**  
,Maroko'



**GAVA 033,**  
,Maroko'  
**033/2**  
,Maroko'



DecorGlass üvegek / DecorGlass glasses



**GAVA 033**  
,Rubín'

**GAVA 033/2**  
'Rubín'



**GAVA 032**  
,Rain'

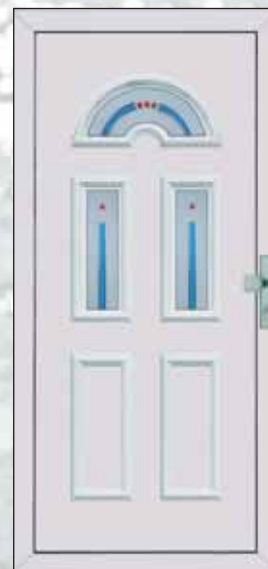

**GAVA 032**  
,Rubín'

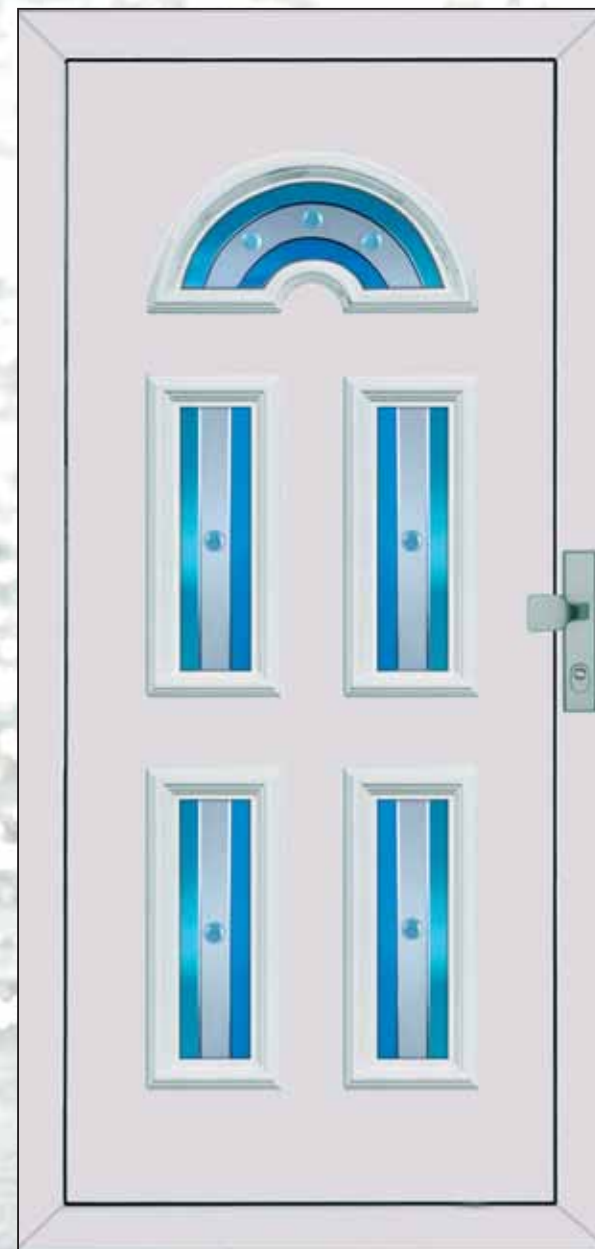

**GAVA 033**  
,Rain'

DecorGlass üvegek / DecorGlass glasses



GAVA 031  
,Rose'



GAVA 032  
,Rose'

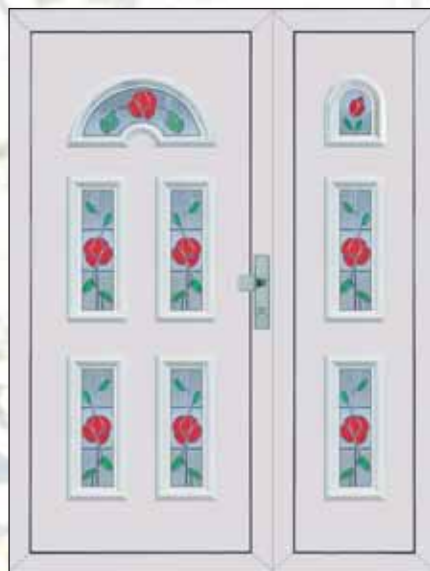

GAVA 033  
,Rose'

GAVA 033/2  
,Rose'



GAVA 032  
,Iris'



GAVA 032  
,Water-Lily'



GAVA 032  
,Violet'



GAVAplast CLASSIC

GAVA 030

12-13

DecorGlass üvegek / DecorGlass glasses



GAVA **041** aranytölgy / golden Oak,  
'Symphony'



GAVA **040**



GAVA **041**



GAVA **042,** **042/2**

DecorGlass üvegek / DecorGlass glasses



GAVA **041**  
'Frame'



GAVA **041**  
'Leaves'



GAVA **041**  
'Laura'





DecorGlass üvegek / DecorGlass glasses



GAVA 074  
,Rain'

GAVA 074/2  
,Rain'

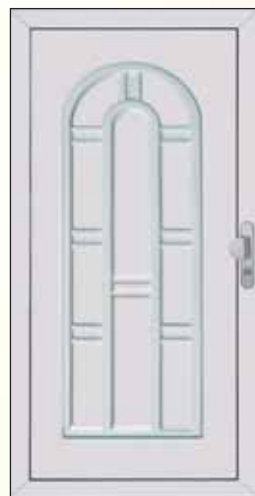

GAVA 070



GAVA 071  
aranytölgy /  
golden Oak



GAVA 072    072/2



GAVA 073



GAVA 074    074/2



GAVA 075

DecorGlass üvegek / DecorGlass glasses



GAVA 063  
,Polár'

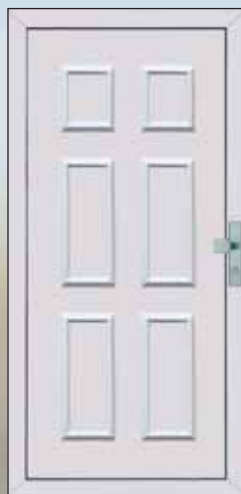

GAVA 060

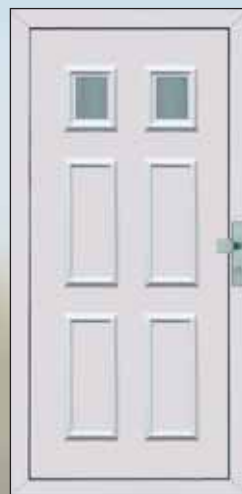

GAVA 061



GAVA 062

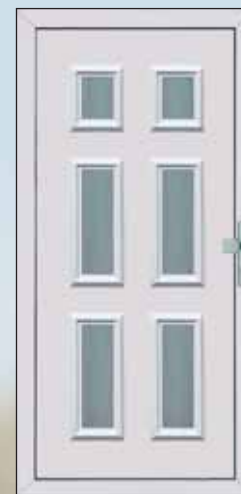

GAVA 063

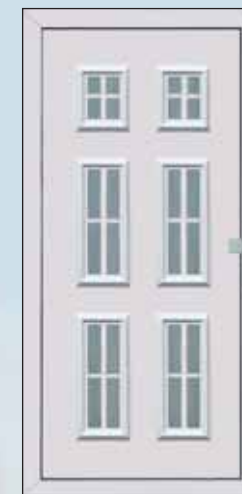

GAVA 064  
16mm-es fehér álosz-  
tóval / 16mm white  
lattice at

DecorGlass üvegek / DecorGlass glasses



GAVA 062  
,River'



062/2  
,River'

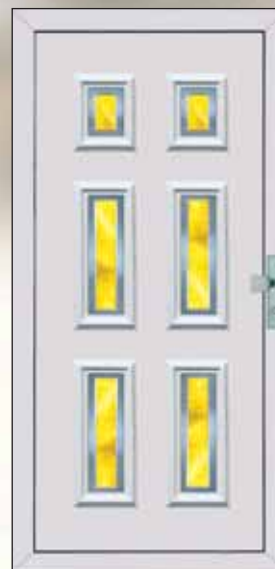

GAVA 063  
,Maroko'



GAVA 063  
,Spike'



GAVA 280



GAVA 281



GAVA 282



GAVA 283



**GAVAplast** CLASSIC

GAVA 060  
GAVA 280  
16-17

DecorGlass üvegek / DecorGlass glasses



GAVA 241/2 extra, GAVA 241, 241/2



GAVA 240



GAVA 241  
,Flora'





**GAVA 081**  
,Spiral'



**GAVA 081**  
,Plane'



**GAVA 080**



**GAVA 081, 081/2**



**GAVA 082**



**GAVA 250**



**GAVA 251**



GAVA 090



GAVA 091



GAVA 091  
aranytölgy / golden Oak

DecorGlass üvegek / DecorGlass glasses



**GAVA 091**  
,Wave'



**GAVA 091**  
,Sinus'



**GAVA 091**  
,Jane'



**GAVA 260**



**GAVA 091**  
,Washington'



**GAVA 091**  
,Sahara'



**GAVA 091**  
,Moon'



**GAVA 261**

DecorGlass üvegek / DecorGlass glasses



GAVA 052  
,Forum'



GAVA 050



GAVA 050  
aranytölgy /  
golden Oak



GAVA 051



GAVA 050/2, GAVA 052  
052/2





DecorGlass üvegek / DecorGlass glasses



GAVA 232  
,Brilliant'

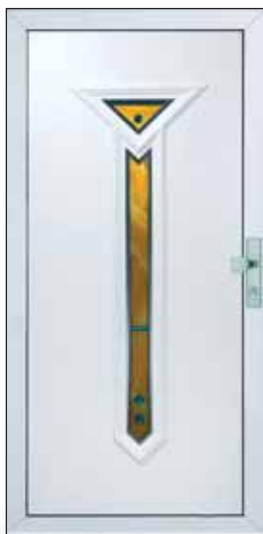

GAVA 232  
,Fortuna'



GAVA 232  
,Spiral'



GAVA 230



GAVA 231

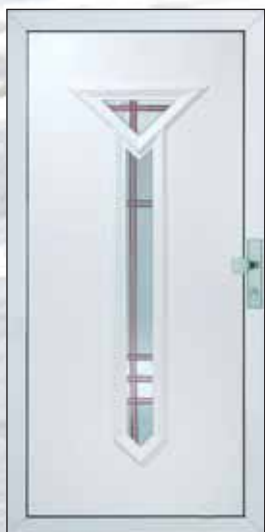

GAVA 232  
,Kompas'

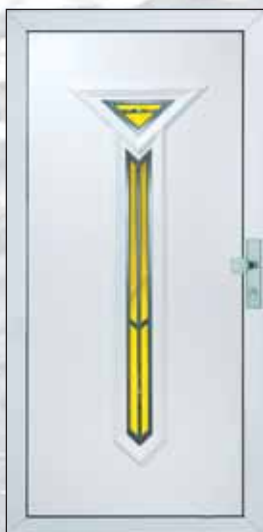

GAVA 232  
,Vector'



GAVA 232

**GAVAplast** MODERN

GAVA 050  
GAVA 230  
22-23



**GAVA 101 P**  
 homokfúvott üveg ,négyzetek 3x12'/  
 sandblasted glass , 3x12 squares'  
 Float -planitherm

**GAVA 101/2 P**  
 homokfúvott üveg ,négyzetek 12' /  
 sandblasted glass , 12 squares'  
 Float -planitherm



**GAVA 100**



**GAVA 101**

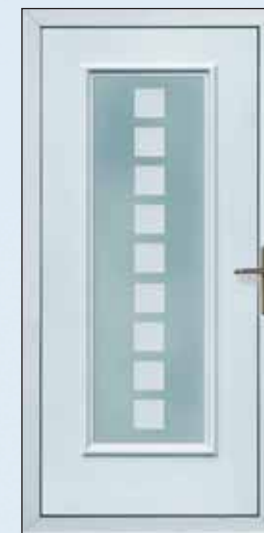

**GAVA 101 P**  
 homokfúvott üveg ,négyzetek 9'/  
 sandblasted glass , 9 squares'



**GAVA 110**



**GAVA 111**



**GAVA 112**



**GAVA 121**  
,Master-carré' üveggel /  
,Master-carré' glass



**GAVA 120**



**GAVAplast** MODERN

GAVA 100  
GAVA 120  
24-25

DecorGlass üvegek / DecorGlass glasses



**GAVA 101**  
,Theby'

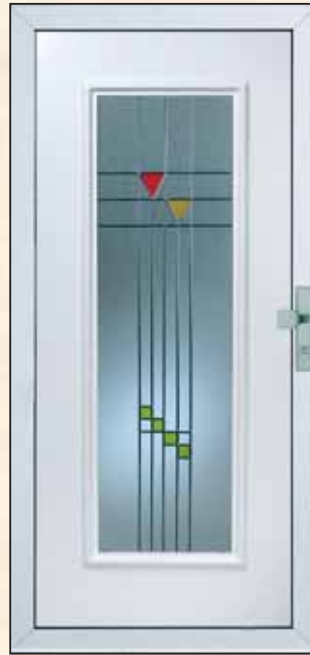

**GAVA 101**  
,Progres'

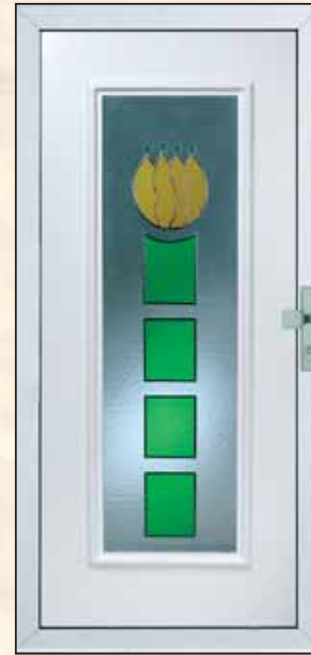

**GAVA 101**  
,Tulip'

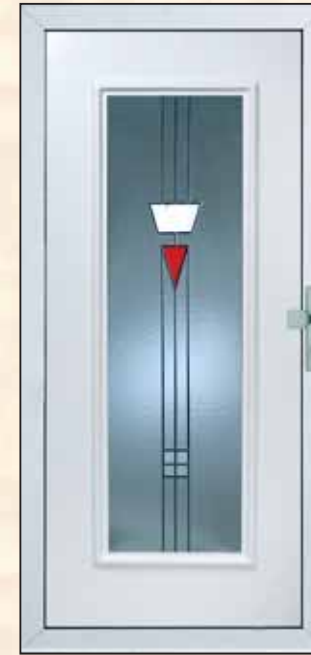

**GAVA 101**  
,Prima'



**GAVA 101**  
,Bird'



**GAVA 101/2 extra, 101, 101/2**



DecorGlass üvegek / DecorGlass glasses



**GAVA 101**  
'Future'



**GAVA 101**  
'Light Ray'

**GAVAplast** MODERN

GAVA 101

26-27



**GAVA 131**

**GAVA 131/2**



**GAVA 130**



**GAVA 133**



**GAVA 132, GAVA 132/2**



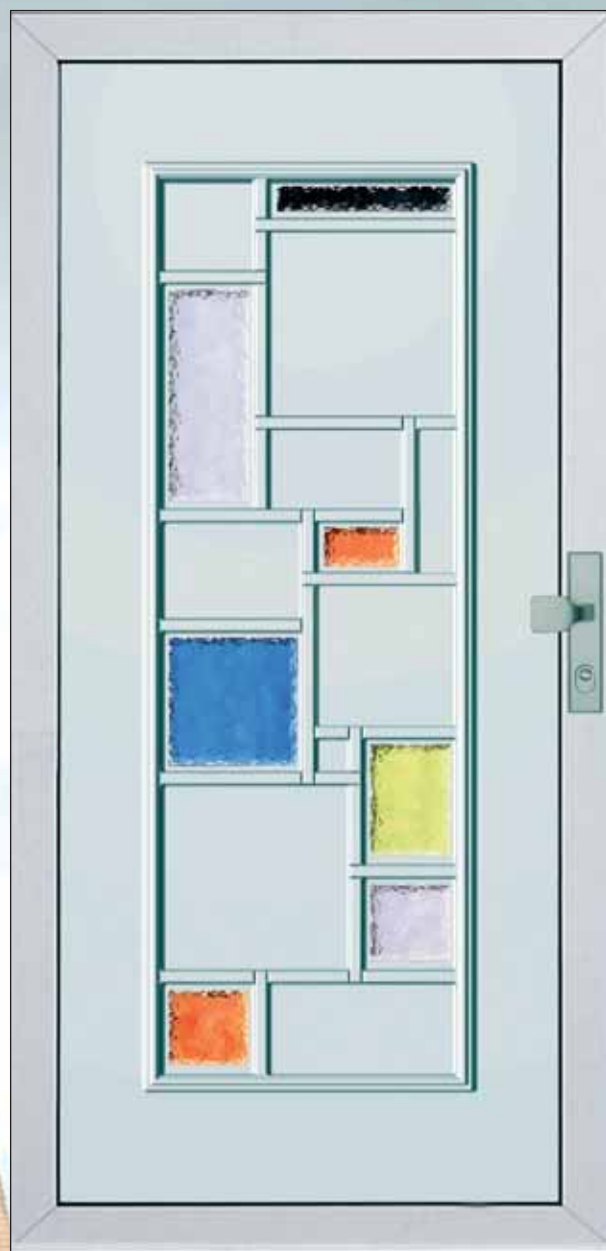

**GAVA 142 C**  
színes üvegek / colored glasses



**GAVA 140**  
antracit



**GAVA 141**

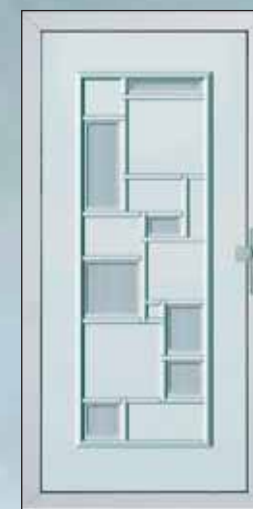

**GAVA 142**



**GAVA 143**

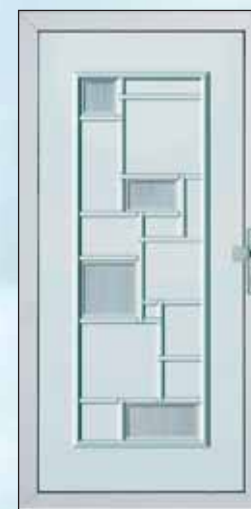

**GAVA 144**



**GAVA 145**



**GAVA 151-P**

homokfúvott üveg ,négyzetek 12' /  
sandblasted glass , 12 squares'  
Float - planitherm

**GAVA 101/2-P**

homokfúvott üveg ,négyzetek 12' /  
sandblasted glass , 12 squares'



**GAVA 160**



**GAVA 161**



**GAVA 170**



**GAVA 171**



**GAVA 181**



**GAVA 150**



**GAVA 151**



**GAVA 152**



**GAVA 153**



DecorGlass üvegek / DecorGlass glasses



GAVA 151  
,Athene'



GAVA 151  
,Drinks'



GAVA 151  
,Harmony'



GAVA 151  
,Lotos'

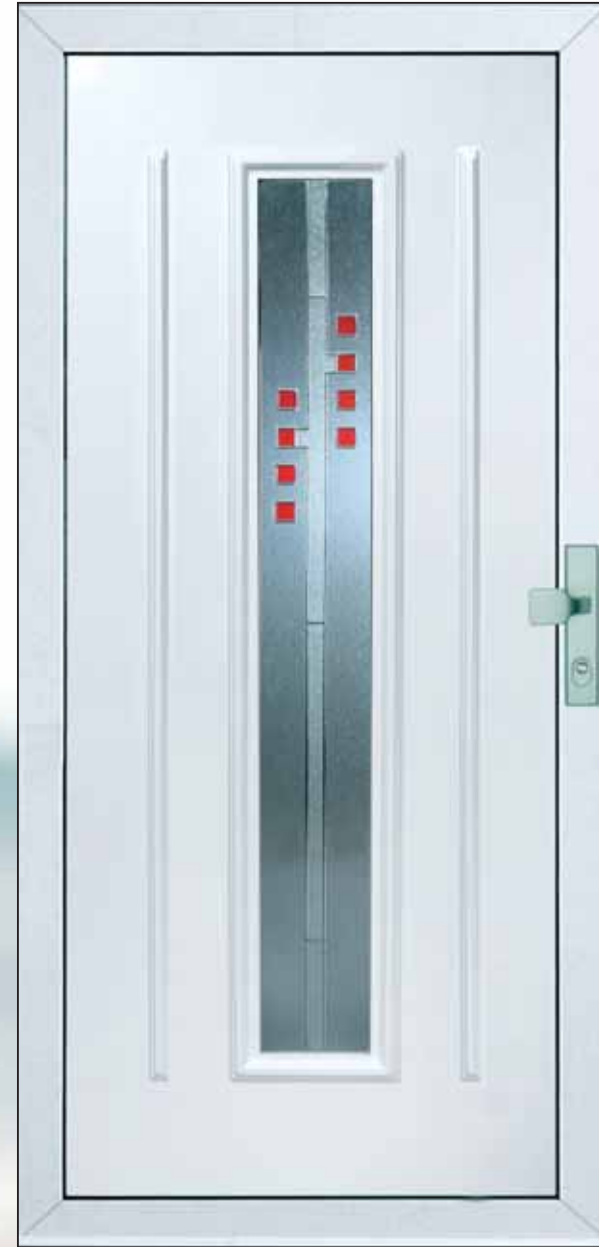

GAVA 151  
,Array'



DecorGlass üvegek / DecorGlass glasses



GAVA 210



GAVA 211

GAVA 211

DecorGlass üvegek / DecorGlass glasses



GAVA 211  
,Carnival'



GAVA 211  
,Figaro'



GAVA 211  
,Game'



GAVA 211  
,Arena'

GAVA 211  
,Arena'

DecorGlass üvegek / DecorGlass glasses



GAVA 200



GAVA 201



GAVA 205



GAVA 206



GAVA 201  
,Bird'



**GAVAplast** MODERN

GAVA 200  
GAVA 210  
32-33

DecorGlass üvegek / DecorGlass glasses



GAVA 221  
,Senegal'



GAVA 221  
,Leaves'



GAVA 221  
,Plejades'



GAVA 221  
,Laura'



GAVA 221  
,Olymp'



GAVA 221  
,Tokaj'



GAVA 221  
,Freeform'



GAVA 221  
,Kankan'



GAVA 225  
,Kankan'



GAVA 221  
,Flora'



**GAVA 220**



**GAVA 221**



**GAVA 222**  
8mm-es arany színű  
áosztóval / 8mm gold  
lattice at



**GAVA 223**  
8mm-es arany színű  
áosztóval / 8mm gold  
lattice at



**GAVA 225/2, GAVA 225**



DecorGlass üvegek / DecorGlass glasses



**GAVA 272**  
,Metric'



**GAVA 272**  
,Harmony'



**GAVA 272**  
,Plane'



**GAVA 272**



**GAVA 270**



**GAVA 272**  
,Flower'



**GAVA 272**  
,Signal'



**GAVA 272**  
,Tennis'

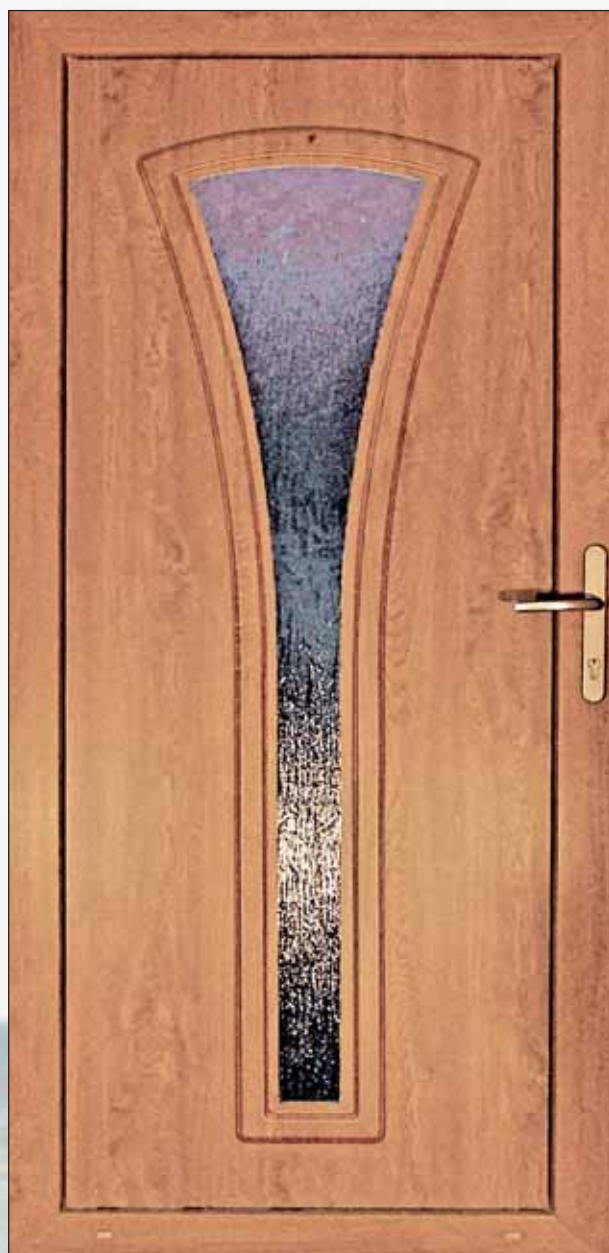

**GAVA 271**  
aranytölgy / golden Oak



**GAVA 273**





GAVA 290



GAVA 291



GAVA 292  
aranytölgy /  
golden Oak



GAVA 292  
sapeli



GAVA 292  
'Linea'







**GAVA 292**  
,Plane'



**GAVA 291**  
,Plane'



**GAVA 291**  
,Linea'



**GAVA 291**  
,Tramín'



**GAVA 291**  
,Color'



**GAVA 293**  
,Color'



GAVA 032



GAVA 292 sapeli

## PVC panelek színválasztéka / PVC panels for color selection



**Mooreiche**  
Renolit 3167 004



**Eiche dunkel**  
Renolit 2052 089



**Sapeli**  
Renolit 2065 021



**Mahagon**  
Renolit 2097 013



**Rosewood**  
Renolit 3202 001



**Nussbaum**  
Renolit 2178 007



**Eiche rustikal**  
Renolit 3149 008



**Macore**  
Renolit 3162 002



**Aranytölgy /  
golden Oak**  
Renolit 2178 001



**Streifendouglas**  
Renolit 3152 009

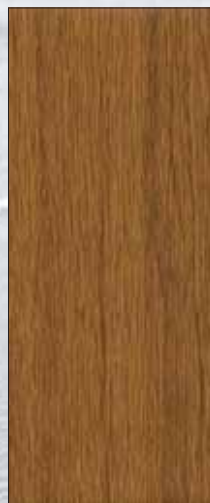

**Eiche hell**  
Renolit 2052 090



**Noce Sorrento  
balsamico**  
Hornschuch  
F439-3042



**Cherry amaretto**  
Hornschuch  
F 425-2043

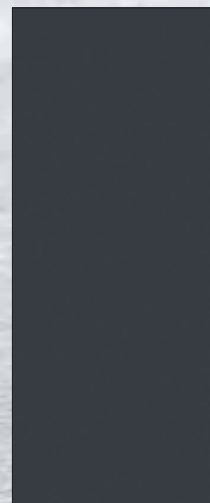

**Anthrazitgrau**  
Renolit 7016 05



**Cremeweiss**  
Renolit 1379 05

## GAVA plast

### Technikai adatok PVC panelekhez

#### Fehér PVC színválaszték:

- C156 – standard fehér
- C145 – salamander fehér
- C152 – Thysen, Veka
- C160 – Gealan, Internova;
- C164 – Rehau

#### Merevítések:

- XPS
- XPS + acéllemez
- Izofix
- Izofix + acéllemez

#### Maximális méretek:

- Főpanel maximális mérete: 850mm – 2000mm ± 2mm
- Oldalpanel maximális mérete: 430mm – 2000mm ± 2mm
- Extra oldalpanel maximális mérete: 850mm – 2000mm ± 2mm (030/2, 100/2, 220/2, 240/2)

Faerezet kivételű panelekbe az IZOFIX merevítés kötelező!

#### Ajtópanelek vastagságai:

- standard panelek vastagságai: 24mm, 34mm, 36mm, 44mm
- egyedi vastagságok: 30mm, 32mm, 40mm, .... stb. egyeztetés alapján gyárthatók

#### Hőátbocsátási tényezők:

- 24 mm: XPS Styrodur 24  $u= 1,04 \text{ W.m}^{-2}.\text{K}^{-1}$  Izofix 24  $u= 1,73 \text{ W.m}^{-2}.\text{K}^{-1}$
- 34 mm: XPS Styrodur 34  $u= 0,91 \text{ W.m}^{-2}.\text{K}^{-1}$  Izofix 34  $u= 0,97 \text{ W.m}^{-2}.\text{K}^{-1}$
- 36 mm: XPS Styrodur 36  $u= 0,87 \text{ W.m}^{-2}.\text{K}^{-1}$  Izofix 36  $u= 1,07 \text{ W.m}^{-2}.\text{K}^{-1}$
- 44 mm: XPS Styrodur 44  $u= 0,72 \text{ W.m}^{-2}.\text{K}^{-1}$  Izofix 44  $u= 0,86 \text{ W.m}^{-2}.\text{K}^{-1}$

XPS Styrodur 24 + acéllemez  $u= 1,34 \text{ W.m}^{-2}.\text{K}^{-1}$

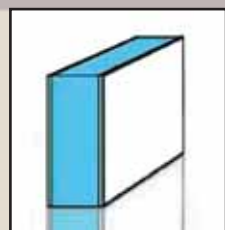

XPS

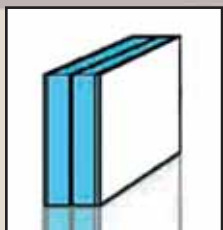

XPS+acéllemez/steel

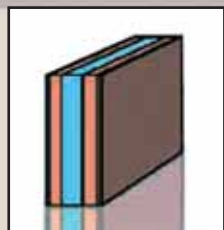

IZOFIX

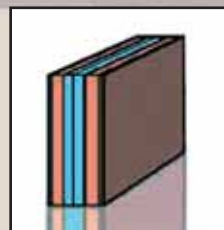

IZOFIX+acéllemez/steel

## Technical description

### GAVA plast PVC panels

#### White PVC boards:

- C156 – used as standard
- C145 – Salamander
- C152 – Thysen, Veka
- C160 – Gealan, Internova;
- C164 – Rehau

#### Fixings:

- XPS
- XPS + steel
- Izofix
- Izofix + steel

#### Maximal dimensions:

- max dimensions of door-infills: 850mm – 2000mm ± 2mm
- max dimensions of side-infills: 430mm – 2000mm ± 2mm
- max dimensions of extra side-infills: 850mm – 2000mm ± 2mm (030/2, 100/2, 220/2, 240/2)

Wood grain design panel in the IZOFIX bracing required!

#### Door panel thickness:

- Standard panel thickness: 24mm, 34mm, 36mm, 44mm
- thicknesses of individual: 30mm, 32mm, 40mm, .... arrangement can be produced

#### Heat transfer coefficient:

- 24 mm: XPS Styrodur 24  $u= 1,04 \text{ W.m}^{-2}.\text{K}^{-1}$  Izofix 24  $u= 1,73 \text{ W.m}^{-2}.\text{K}^{-1}$
- 34 mm: XPS Styrodur 34  $u= 0,91 \text{ W.m}^{-2}.\text{K}^{-1}$  Izofix 34  $u= 0,97 \text{ W.m}^{-2}.\text{K}^{-1}$
- 36 mm: XPS Styrodur 36  $u= 0,87 \text{ W.m}^{-2}.\text{K}^{-1}$  Izofix 36  $u= 1,07 \text{ W.m}^{-2}.\text{K}^{-1}$
- 44 mm: XPS Styrodur 44  $u= 0,72 \text{ W.m}^{-2}.\text{K}^{-1}$  Izofix 44  $u= 0,86 \text{ W.m}^{-2}.\text{K}^{-1}$

XPS Styrodur 24 + steel  $u= 1,34 \text{ W.m}^{-2}.\text{K}^{-1}$



# **GAVA** *aluminium*

**AJTÓBETÉTEKMŰANYAG ÉS ALUMÍNIUMPROFILRENDSZEREKHEZ**  
**DOOR-INFILL PANELS FOR ALUMINIUM & PLASTIC SYSTEMS**

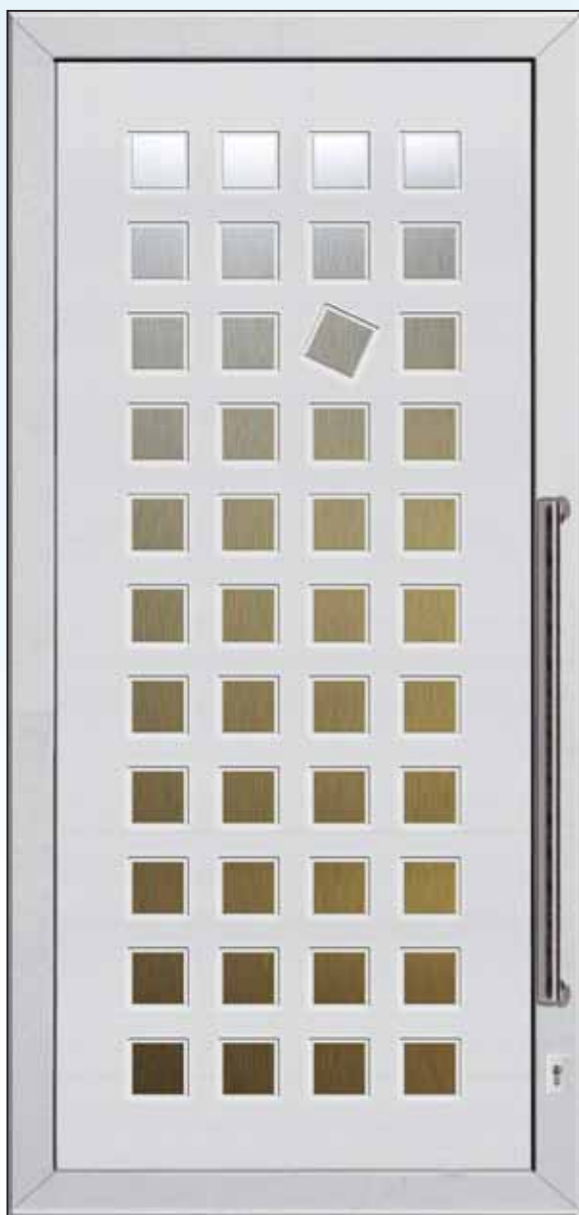

## GAVA 407a

rozsdamentes acél négyzetek /  
stainless steel squares





**GAVA 400**



**GAVA 401**



**GAVA 402**  
RAL 1005



**GAVA 407b**  
RAL 5003



**GAVA 407c**  
RAL 3020  
RAL 9016



**GAVA 405**  
RAL 1020



**GAVA 403**  
RAL 6003



**GAVA 404**



**GAVA 406**



**GAVA 408**

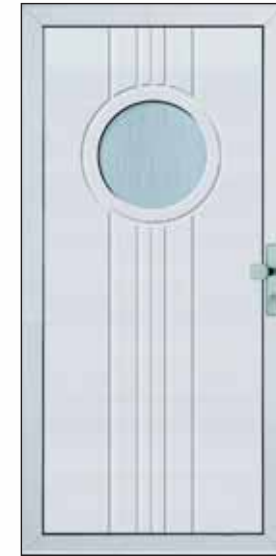

**GAVA 409**



**GAVA 416a**  
RAL 9006



**GAVA 416a**  
RAL 5003



**GAVA 416b**  
RAL 8024





GAVA 416b

## GAVA 416c

RAL 8024

rozsdamentes acél kombináció /  
a combination of stainless steel



AREA GAVA  
aluminium

GAVA 400  
GAVA 410  
46-47

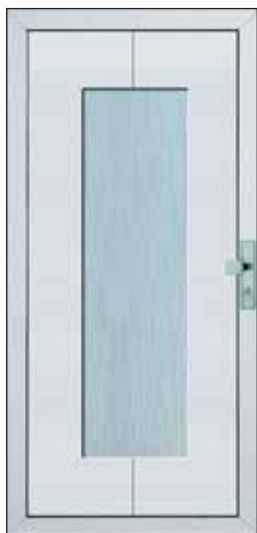

**GAVA 410**

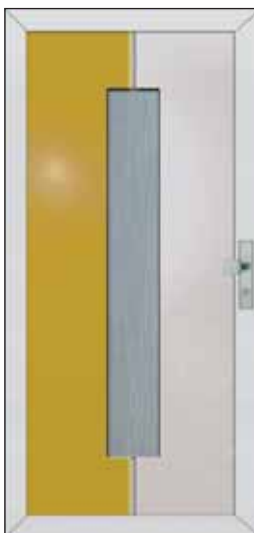

**GAVA 411**  
RAL 1005



**GAVA 411**  
RAL 5003



**GAVA 415 b**  
RAL 6026



**GAVA 417**

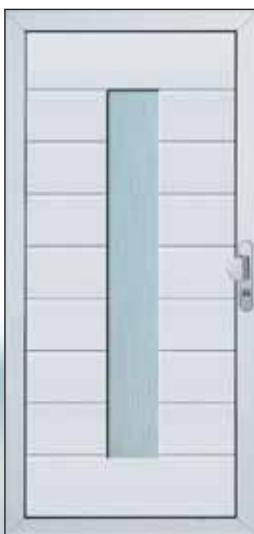

**GAVA 418**



**GAVA 419 a**  
homokfúvott üveg /  
sandblasted glass

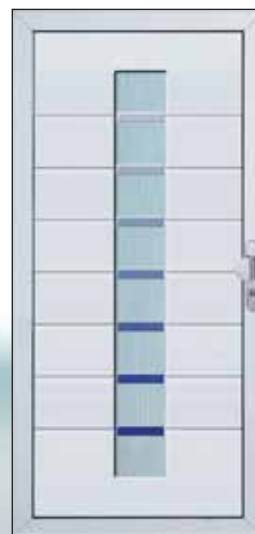

**GAVA 419 b**



**GAVA 417**  
RAL 5003





**GAVA 412**  
rozsdamentes acél  
kombináció /  
a combination of stainless  
steel

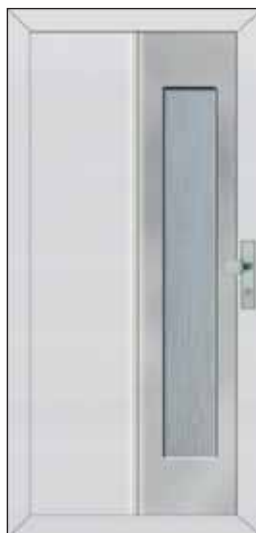

**GAVA 414**  
RAL 9006



**GAVA 413**  
RAL 9006



**GAVA 413**  
RAL 3003



**GAVA 413b**  
rozsdamentes acél kombináció /  
a combination of stainless steel

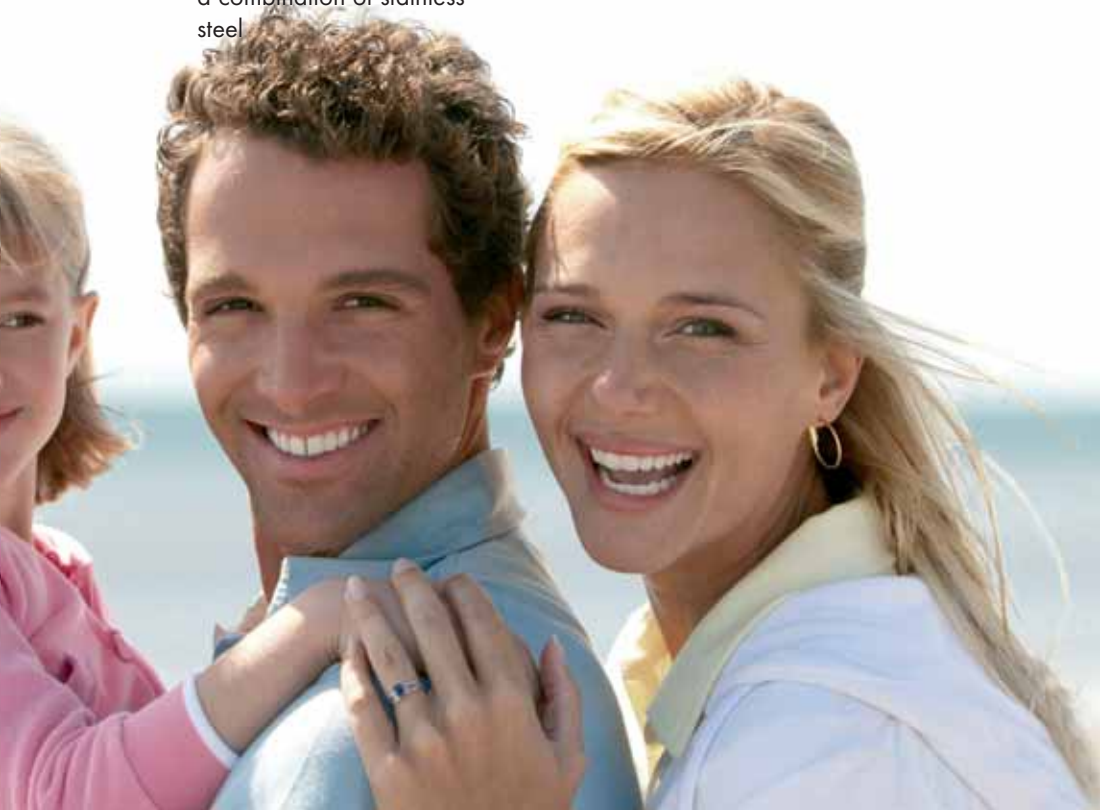



## **GAVA 429**

rozsdamentes acél kombináció /  
a combination of stainless steel



**GAVA 428**  
RAL 8024

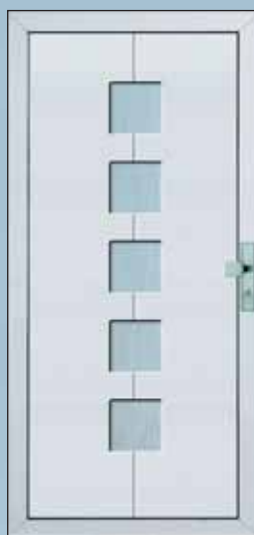

**GAVA 426**

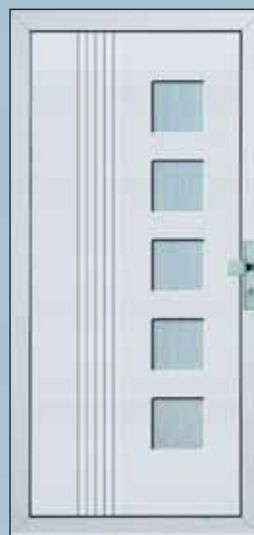

**GAVA 427**



**GAVA 428**



**GAVA 425b**  
rozsdamentes acél  
kombináció /  
a combination of stainless  
steel



**GAVA 429**  
RAL 5003  
rozsdamentes acél  
kombináció / a combina-  
tion of stainless steel



**GAVA 429**  
RAL 6026  
rozsdamentes acél  
kombináció / a combina-  
tion of stainless steel



**GAVA 429**  
RAL 1017  
rozsdamentes acél  
kombináció / a combination  
of stainless steel



**GAVA 424**

RAL 8024 rozsdamentes acél kombináció /  
a combination of stainless steel

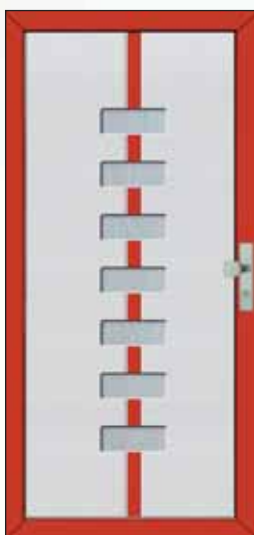

**GAVA 420**  
RAL 3020



**GAVA 421**  
RAL 9006

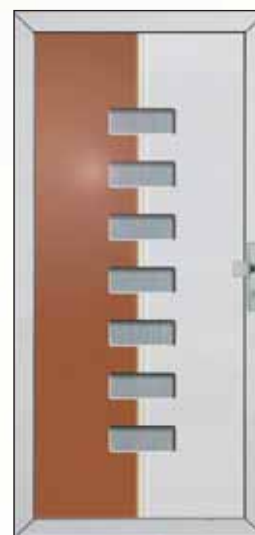

**GAVA 421**  
RAL 8023

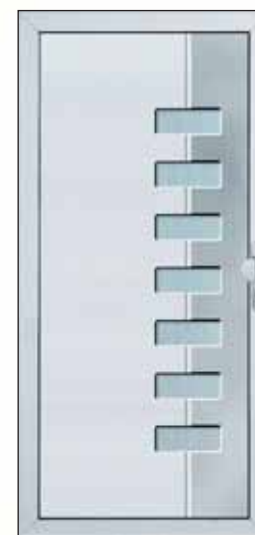

**GAVA 422**  
RAL 9006



**GAVA 423**



**GAVA 423**  
RAL 5003

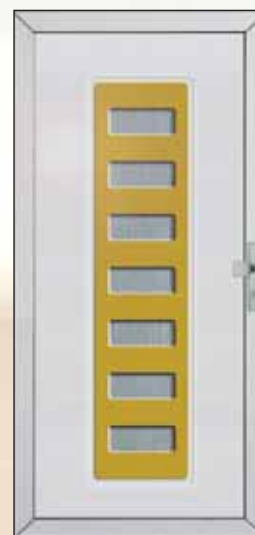

**GAVA 425**  
RAL 1005





**GAVA 437 a**  
RAL 9006



**GAVA 437 b**  
rozsdamentes acél  
kombináció /  
a combination of stain-  
less steel



**GAVA 437c**  
RAL 3003 rozsdamentes acél kombináció /  
a combination of stainless steel

**CIRCLES** **GAVA**  
aluminium

GAVA 420  
GAVA 430  
52-53



**GAVA 430**



**GAVA 431**  
RAL 8023



**GAVA 432**  
RAL 5003



**GAVA 435 a**  
RAL 1017  
RAL 6003



**GAVA 433**  
RAL 9006

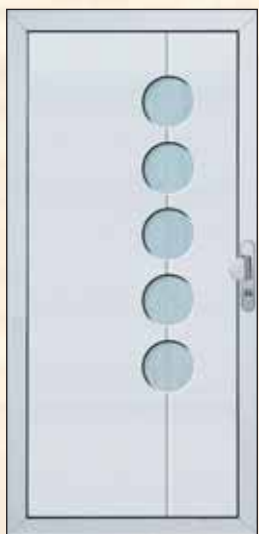

**GAVA 436**



**GAVA 438 a**  
homokfúvott üveg /  
sandblasted glass



**GAVA 439**  
rozsdamentes acél  
kombináció / a combination  
of stainless steel



**GAVA 435 b**  
rozsdamentes acél  
kombináció / a combination of  
stainless steel





GAVA 434

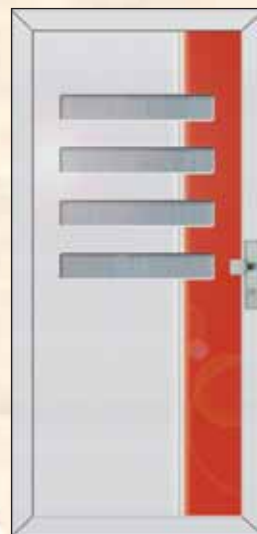

GAVA 447  
RAL 3020



GAVA 448

RAL 8024 rozsdamentes acél kombináció /  
a combination of stainless steel



COMPOSITIONS **GAVA**  
aluminium

GAVA 430  
GAVA 440  
54-55

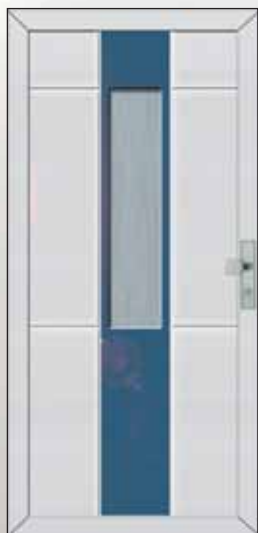

**GAVA 440 a**  
RAL 5021



**GAVA 440 b**  
RAL 5003  
rozsdamentes acél  
kombináció / a combina-  
tion of stainless steel

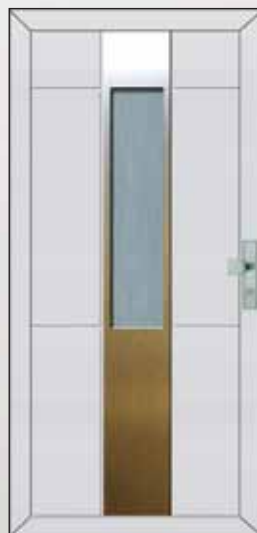

**GAVA 440 b**  
rozsdamentes acél  
kombináció / a combina-  
tion of stainless steel



**GAVA 441a**  
RAL 3003



**GAVA 441c**  
rozsdamentes acél  
kombináció / a combina-  
tion of stainless steel



**GAVA 442**  
rozsdamentes acél  
kombináció / a combina-  
tion of stainless steel



**GAVA 443**  
rozsdamentes acél  
kombináció / a combina-  
tion of stainless steel

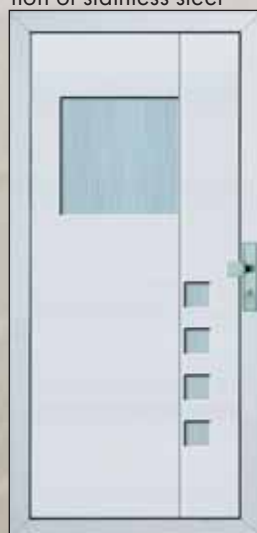

**GAVA 444a**



**GAVA 444b**  
rozsdamentes acél  
kombináció / a combina-  
tion of stainless steel



**GAVA 445**



**GAVA 446**



**GAVA 449**  
rozsdamentes acél  
kombináció / a combina-  
tion of stainless steel



**GAVA**  
aluminium

# COMPOSITIONS

GAVA 440

56-57



## GAVA 452 a

rozsdamentes acél kombináció /  
a combination of stainless steel



## GAVA 452 b

RAL 1017,  
RAL 9006





**GAVA 450 b**  
RAL 5003  
rozsdamentes acél  
kombináció / a combina-  
tion of stainless steel



**GAVA 453 b**  
rozsdamentes acél  
kombináció / a combina-  
tion of stainless steel



**GAVA 454 b**  
rozsdamentes acél  
kombináció / a combina-  
tion of stainless steel

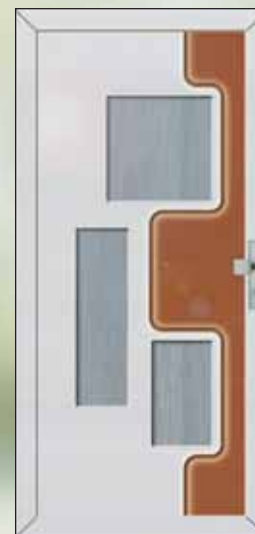

**GAVA 455**  
RAL 8023

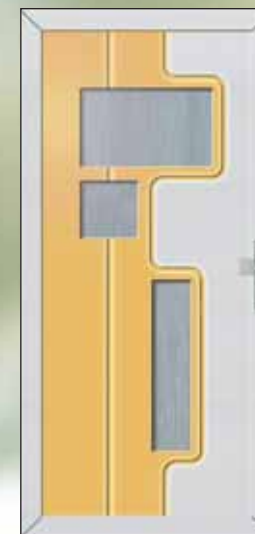

**GAVA 456**  
RAL 1017



**GAVA 451**  
rozsdamentes acél  
kombináció, homokfúvott  
üveg / a combination of  
stainless steel, sandblasted  
glass



**GAVA 457**  
RAL 5021



**GAVA 457**  
RAL 5021

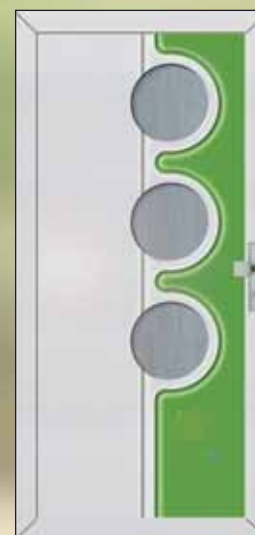

**GAVA 458**  
RAL 6018

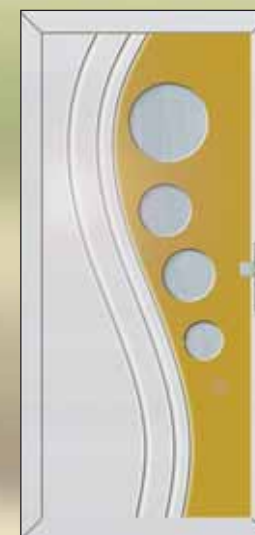

**GAVA 459**  
RAL 1005



**GAVA 460**



**GAVA 461**  
homokfúvott üveg /  
sandblasted glass



**GAVA 462**



**GAVA 464a**



**GAVA 464b**

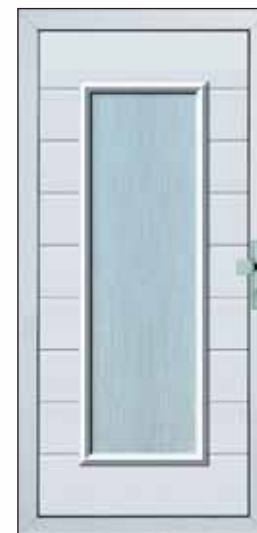

**GAVA 465**

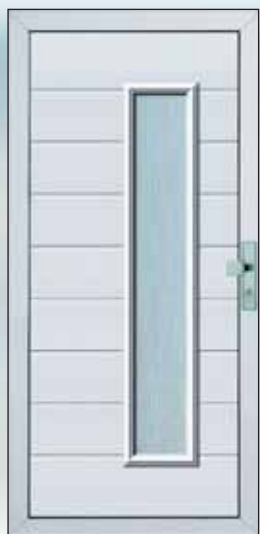

**GAVA 466**



**GAVA 467**

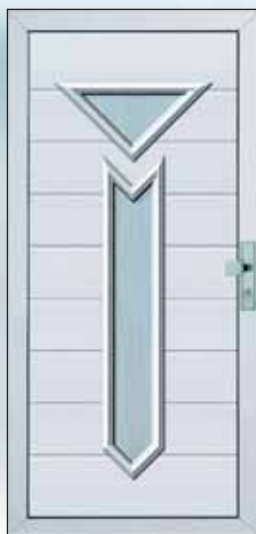

**GAVA 468**



**GAVA 469**



**GAVA 463a**



**GAVA 463b**  
RAL 9006  
RAL 9016



## GAVA 463c

rozsdamentes acél kombináció /  
a combination of stainless steel



**GAVA**  
aluminium  
**PROFILES**

GAVA 460

60-61



**GAVA 470a**



**GAVA 470b**  
RAL 5003



**GAVA 476**  
RAL 9007



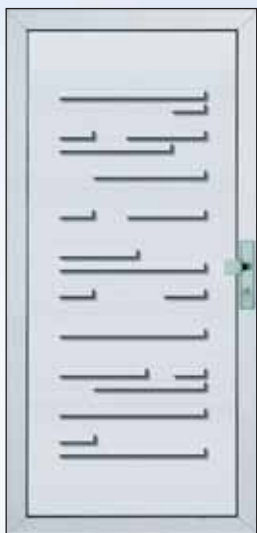

GAVA 471

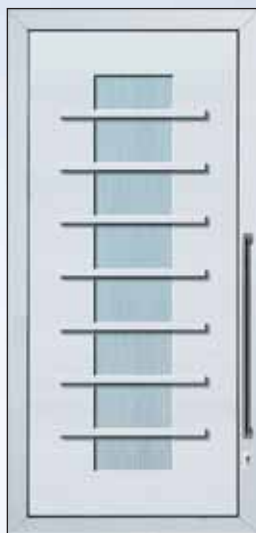

GAVA 472

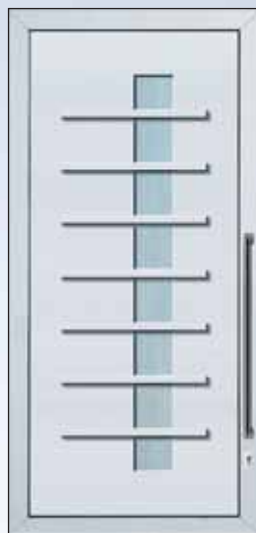

GAVA 473

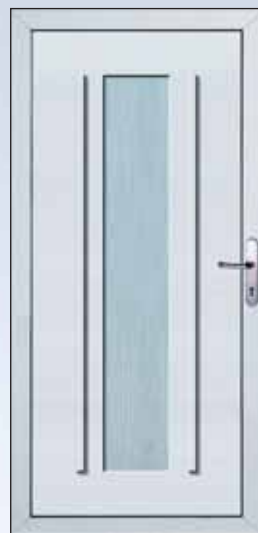

GAVA 474 a



GAVA 474 b  
rozsdamentes acél  
kombináció / a combina-  
tion of stainless steel



GAVA 479



GAVA 475



GAVA 475 b  
RAL 3003,  
RAL 9016

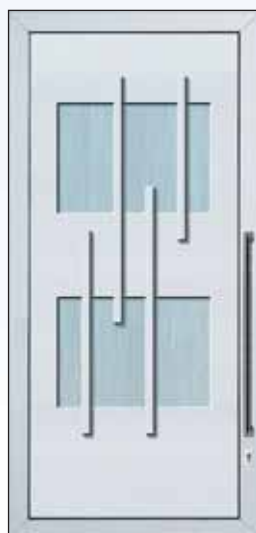

GAVA 478



GAVA 477



GAVA 483

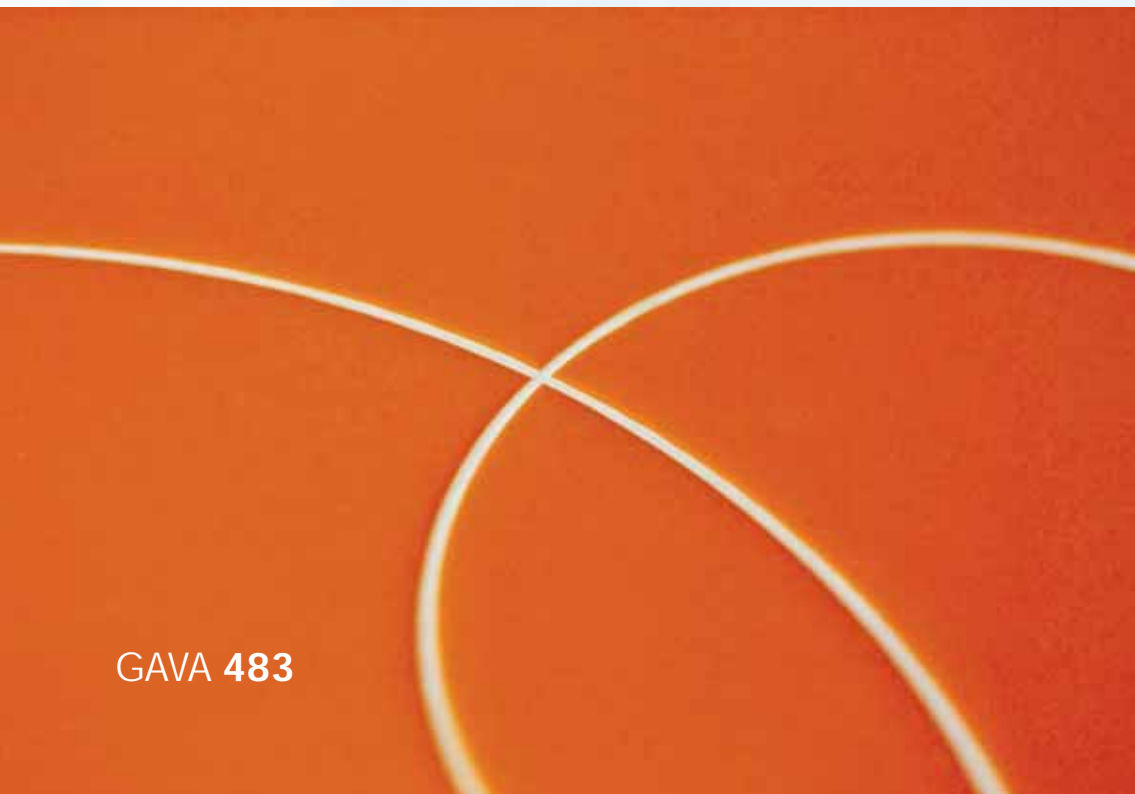

GAVA 483

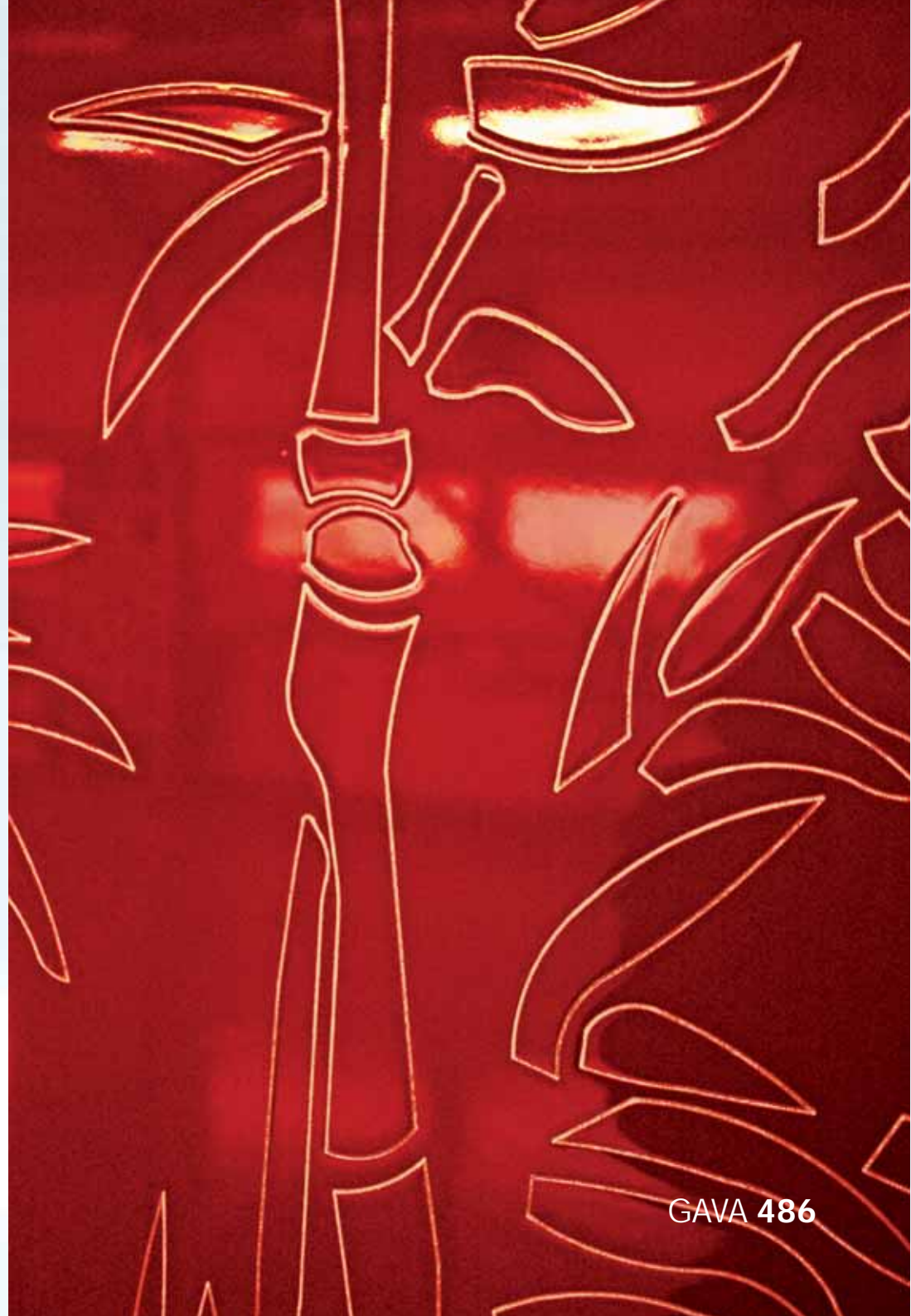

GAVA 486



GAVA 480  
RAL 1005

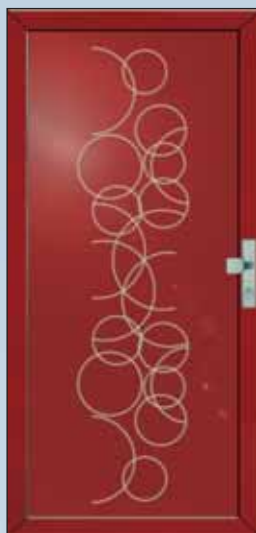

GAVA 481  
RAL 3003

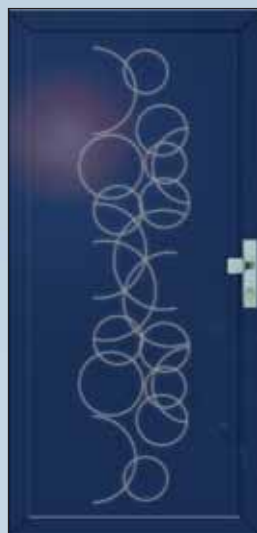

GAVA 481  
RAL 5003



GAVA 486  
RAL 5003



GAVA 483  
RAL 3020



GAVA 482  
RAL 5003

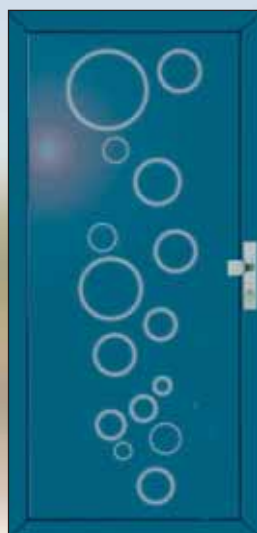

GAVA 482  
RAL 5021



GAVA 486  
RAL 3003

NATURE INSPIRATION **GAVA** aluminium

GAVA 480  
64-65



**GAVA 484a**  
RAL 8024  
rozsdamentes acél  
kombináció / a combination  
of stainless steel



**GAVA 487**  
RAL 5003



**GAVA 487a**  
RAL 6003  
rozsdamentes acél  
kombináció / a combina-  
tion of stainless steel



**GAVA 487a**  
RAL 8024  
rozsdamentes acél  
kombináció / a combina-  
tion of stainless steel

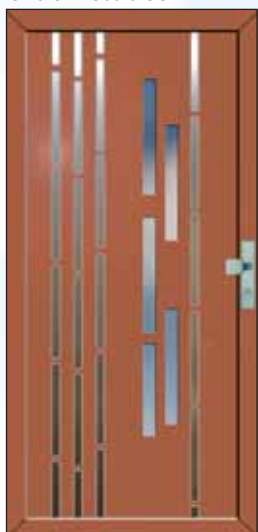

**GAVA 488a**  
RAL 8023  
rozsdamentes acél  
kombináció / a combina-  
tion of stainless steel

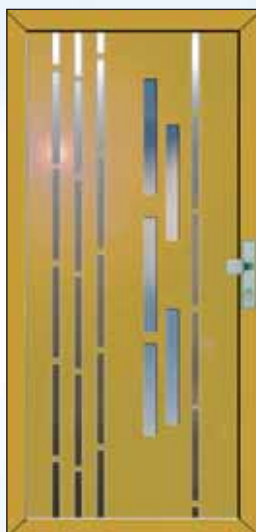

**GAVA 488a**  
RAL 1005  
rozsdamentes acél  
kombináció / a combina-  
tion of stainless steel

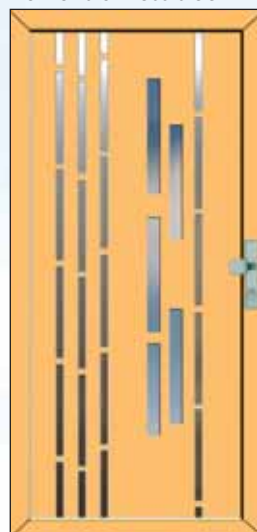

**GAVA 488a**  
RAL 1017  
rozsdamentes acél  
kombináció / a combina-  
tion of stainless steel



**GAVA 485**  
RAL 5003



**GAVA 485**  
RAL 1005



**GAVA 487a**

**RAL 3003,**

rozsdamentes acél kombináció / a combination of stainless steel



**NATURE INSPIRATION** **GAVA**  
aluminium

GAVA 480  
66-67

A grid of 24 color swatches arranged in 6 columns and 4 rows. Each swatch is a vertical rectangle with a thin black border and a numerical label centered on it. The colors vary across the grid, including shades of green, yellow, orange, red, brown, and purple. The labels are: 1000, 1013, 1024, 2004, 3004, 3017; 1001, 1014, 1027, 2008, 3005, 3018; 1002, 1015, 1028, 2009, 3007, 3020; 1003, 1016, 1032, 2010, 3009, 3022; 1004, 1017, 1033, 2011, 3011, 3027; 1005, 1018, 1034, 2012, 3012, 3031; 1006, 1019, 2000, 3000, 3013, 4001; 1007, 1020, 2001, 3001, 3014, 4002; 1011, 1021, 2002, 3002, 3015, 4003; 1012, 1032, 2003, 3003, 3016, 4004.

1000	1013	1024	2004	3004	3017
1001	1014	1027	2008	3005	3018
1002	1015	1028	2009	3007	3020
1003	1016	1032	2010	3009	3022
1004	1017	1033	2011	3011	3027
1005	1018	1034	2012	3012	3031
1006	1019	2000	3000	3013	4001
1007	1020	2001	3001	3014	4002
1011	1021	2002	3002	3015	4003
1012	1032	2003	3003	3016	4004

**GAVA aluminium** színválaszték RAL színskála szerint / **GAVA aluminum** colors according to RAL color chart

4005	5005	5017	6002	6012	6022	7000	7011	7030	7040	8008	8024
4006	5007	5018	6003	6013	6024	7001	7012	7031	7042	8011	8025
4007	5008	5019	6004	6014	6025	7002	7013	7032	7043	8012	8028
4008	5009	5020	6005	6015	6026	7003	7015	7033	7044	8014	9001
4009	5010	5021	6006	6016	6027	7004	7016	7034	8000	8015	9002
5000	5011	5022	6007	6017	6028	7005	7021	7035	8001	8016	9003
5001	5012	5023	6008	6018	6029	7006	7022	7036	8002	8017	9004
5002	5013	5024	6009	6019	6032	7008	7023	7037	8003	8019	9005
5003	5014	6000	6010	6020	6033	7009	7024	7038	8004	8022	9006
5004	5015	6001	6011	6021	6034	7010	7026	7039	8007	8023	9007

## **GAVA aluminium**

### Technikai adatok alumínium panelekhez:

Ajtópanelek felülete minőségi porfestékkel, porszórással készülnek, kiválasztott RAL színek alapján.

Lehetőség van rozsdamentes szálcsiszolt acél kombinációra.

#### Maximális méretek:

- STANDARD: 1000mm × 2000mm
- Egyedi: 1250mm × 2500mm

Részletes méreteket a [www.gavaplast.sk](http://www.gavaplast.sk) honlapon talál.

#### Merevítések:

- XPS
- XPS + acéllemez

#### Ajtópanelek vastagsága:

- Standard vastagság: 24mm, 34mm, 36mm, 44mm
- Egyedi vastagságok: 30mm, 32mm, 40mm, ....stb., egyeztetés alapján gyárthatók

#### Hőátbocsátási tényezők:

- 24 mm vastag: XPS Styrodur 24  $u= 1,11 \text{ W.m}^{-2}.\text{K}^{-1}$
- 24 mm vastag: XPS Styrodur 24 + acél lemez  
 $u= 1,37 \text{ W.m}^{-2}.\text{K}^{-1}$
- 34 mm vastag: XPS Styrodur 34  $u= 0,94 \text{ W.m}^{-2}.\text{K}^{-1}$
- 36 mm vastag: XPS Styrodur 36  $u= 0,89 \text{ W.m}^{-2}.\text{K}^{-1}$
- 44 mm vastag: XPS Styrodur 44  $u= 0,74 \text{ W.m}^{-2}.\text{K}^{-1}$

## **GAVA aluminium**

### Technical data of aluminum panels:

Door panel surface quality of powder, powder are selected based on RAL color.

It is possible in brushed stainless steel combination.

#### Maximum dimensions:

- STANDARD: 1000mm × 2000mm
- Individual: 1250mm × 2500mm

Detailed dimensions of [www.gavaplast.sk](http://www.gavaplast.sk) website.

#### Fixings:

- XPS
- XPS + steel

#### Door panel thickness:

- Standard thickness: 24mm, 34mm, 36mm, 44mm
- Custom thicknesses: 30mm, 32mm, 40mm, .... arrangement can produce

#### Heat transfer coefficient:

- 24 mm thick: XPS Styrodur 24  $u= 1,11 \text{ W.m}^{-2}.\text{K}^{-1}$
- 24 mm thick: XPS Styrodur 24 + steel  
 $u= 1,37 \text{ W.m}^{-2}.\text{K}^{-1}$
- 34 mm thick: XPS Styrodur 34  $u= 0,94 \text{ W.m}^{-2}.\text{K}^{-1}$
- 36 mm thick: XPS Styrodur 36  $u= 0,89 \text{ W.m}^{-2}.\text{K}^{-1}$
- 44 mm thick: XPS Styrodur 44  $u= 0,74 \text{ W.m}^{-2}.\text{K}^{-1}$



GAVA 891  
aranytölgy/  
golden Oak



GAVA 754  
aranytölgy/  
golden Oak



**GAVA hpl**

70-71

AJTÓBETÉTEK MŰANYAG ÉS ALUMÍNIUM PROFILRENDSZEREKHEZ  
DOOR-INFILL PANELS FOR ALUMINIUM & PLASTIC SYSTEMS



**GAVA 691**, aranytölgy, golden Oak  
alu kombináció/  
aluminum combination



**GAVA 691**  
nussbaum,  
alu kombináció/  
aluminum combination



**GAVA 690**  
alu kombináció/  
aluminum combination



**GAVA 691**  
DecorGlass 'Sinus'  
alu kombináció/  
aluminum combination



**GAVA 691**  
DecorGlass 'Wawe'  
alu kombináció/  
aluminum combination



**GAVA 691**  
DecorGlass 'Washington'  
alu kombináció/  
aluminum combination



**GAVA 651**  
alu kombináció/  
aluminum combination



**GAVA 652**  
aranytölgy, golden  
Oak  
alu kombináció/  
aluminum combination



**GAVA 652**  
eiche dunkel,  
alu kombináció/  
aluminum combination



**GAVA 652**  
nussbaum,  
alu kombináció/  
aluminum combination

**652/2**  
aranytölgy,  
golden Oak  
alu kombináció/  
aluminum  
combination



**GAVA 652**  
DecorGlass 'Forum',  
alu kombináció/  
aluminum combination

**GAVA 652/2**  
DecorGlass 'Forum',  
alu kombináció/  
aluminum combination



**GAVA hpl**

GAVA 690  
GAVA 650  
72-73

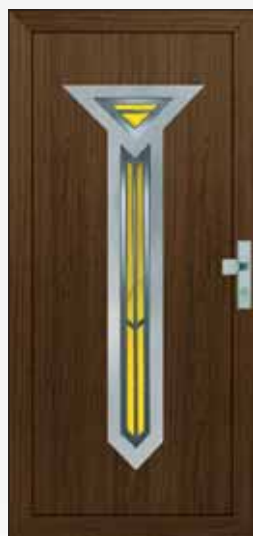

**GAVA 832**  
eiche dunkel,  
DecorGlass 'Vektor'  
alu kombináció/  
aluminum combination

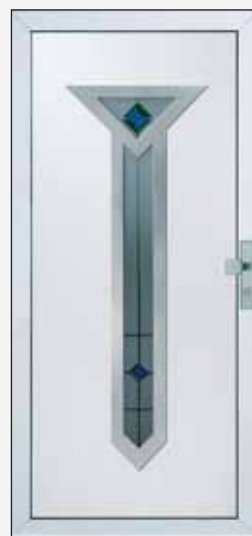

**GAVA 832**  
DecorGlass  
'Briliant '  
alu kombináció/  
aluminum combination



**GAVA 832**, eiche dunkel,  
DecorGlass 'Kompas'  
alu kombináció/  
aluminum combination



**GAVA 831**  
alu kombináció/  
aluminum combination



**GAVA 832**  
aranytölgy, golden Oak  
alu kombináció/  
aluminum combination

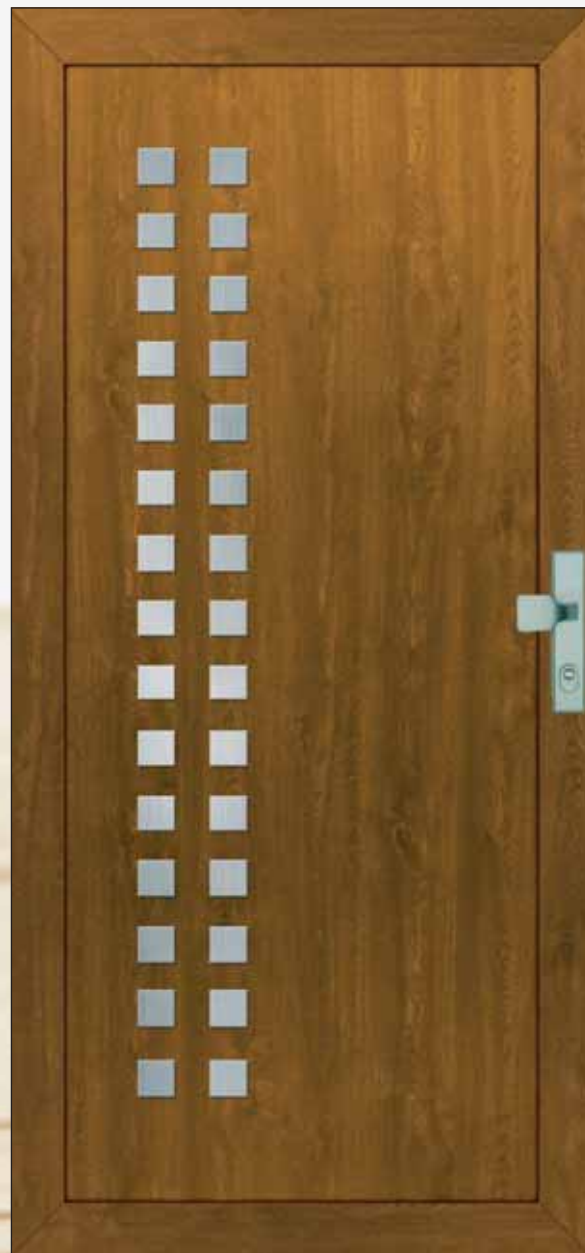

**GAVA 864**  
aranytölgy, golden Oak  
alu kombináció/  
aluminum combination



**GAVA 860**  
alu kombináció/  
aluminum combination

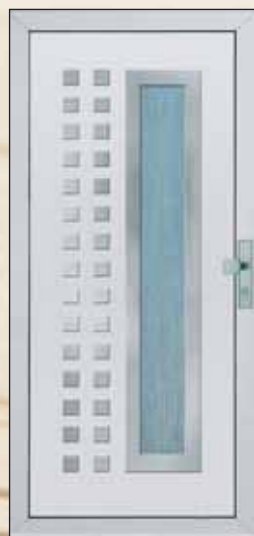

**GAVA 861**  
alu kombináció/  
aluminum combination



**GAVA 862**  
alu kombináció/  
aluminum combination



**GAVA 863**  
nussbaum,  
alu kombináció/  
aluminum combination

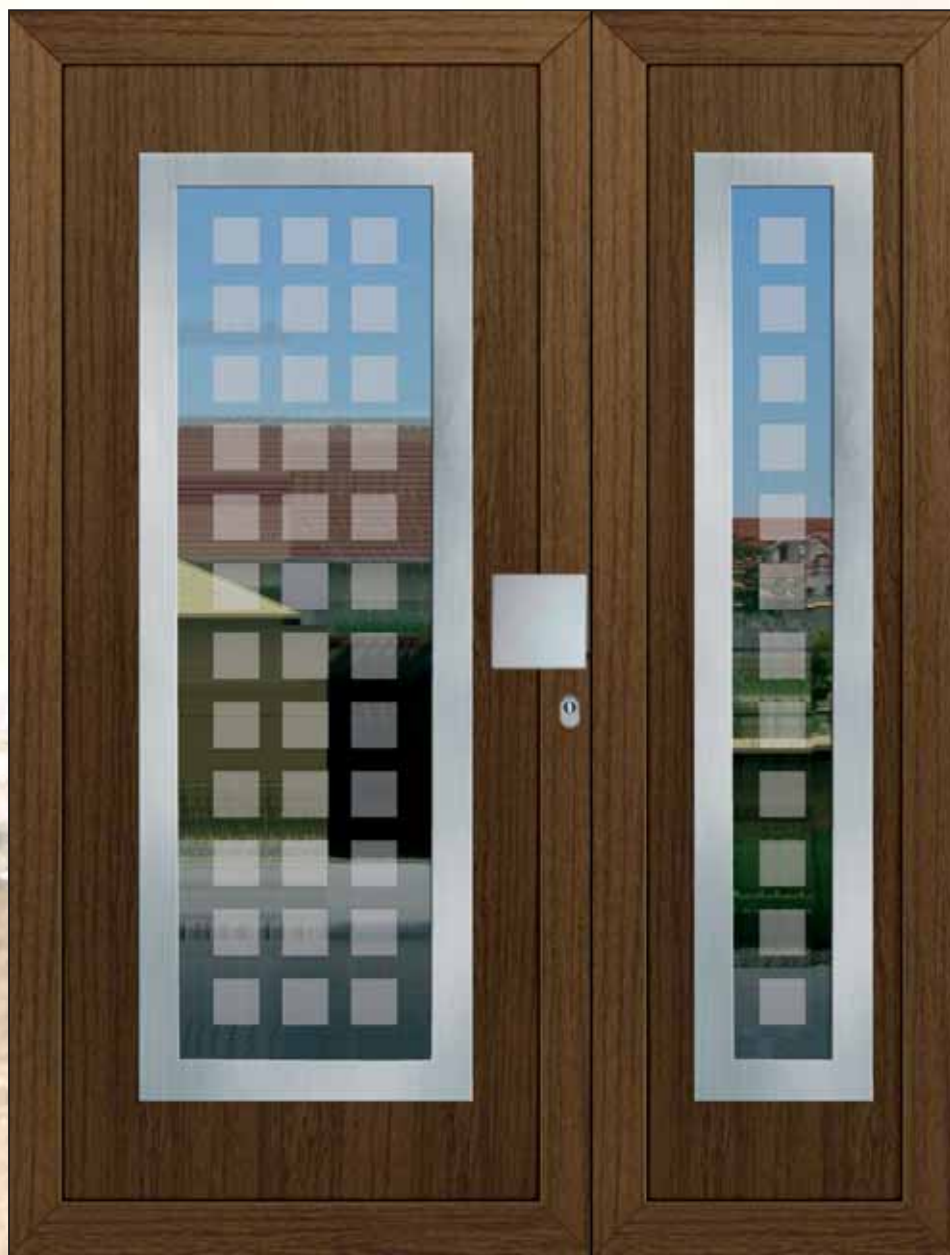

**GAVA 701** eiche dunkel,  
homokfűvott üveg négyzetek,  
alu kombináció / frosted glass  
squares aluminum combination

**GAVA 701/2** eiche dunkel,  
homokfűvott üveg négyzetek,  
alu kombináció / frosted glass  
squares aluminum combination



**GAVA 701**  
nussbaum,  
DecorGlass  
'Light Ray',  
alu kombináció/  
aluminum combination



**GAVA 701**  
eiche dunkel,  
alu kombináció/  
aluminum combination



**GAVA 701**  
DecorGlass 'Progres',  
alu kombináció/  
aluminum combination



**GAVA 702**  
nussbaum,  
alu kombináció/  
aluminum combination



**GAVA 702**  
alu kombináció/  
aluminum combination



**GAVA 754,**  
aranytölgy, golden Oak  
alu kombináció/  
aluminum combination



**GAVA 752**  
eiche dunkel,  
alu kombináció/  
aluminum combination



**GAVA 753**  
nussbaum,  
alu kombináció/  
aluminum combination

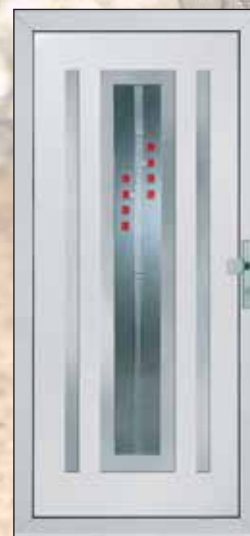

**GAVA 751**  
DecorGlass 'Array',  
alu kombináció/  
aluminum combination



**GAVA hpl**

GAVA 700  
GAVA 750  
76-77



**GAVA 732**  
alu kombináció/  
aluminum combination



**GAVA 731**     **731/2**  
aranytölgy, golden Oak,  
alu kombináció/  
aluminum combination



**GAVA 741**  
alu kombináció/  
aluminum combination



**GAVA 742**  
nussbaum, alu kombináció/  
aluminum combination

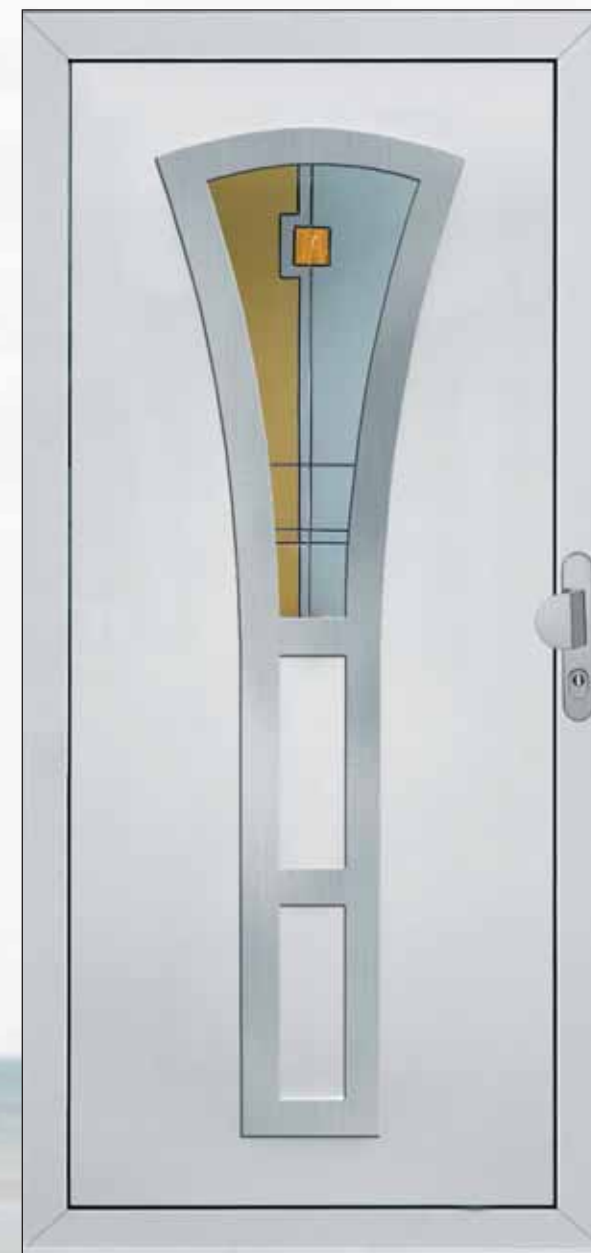

**GAVA 872**  
Decor Glass 'Metric'  
alu kombináció/  
aluminum combination





**GAVA 871**,  
aranytölgy, golden Oak  
alu kombináció/  
aluminum combination



**GAVA 873**,  
nussbaum,  
alu kombináció/  
aluminum combination

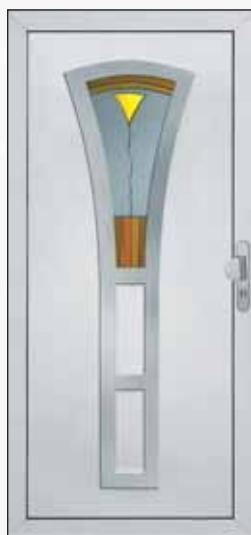

**GAVA 872**  
DecorGlass 'Flower',  
alu kombináció/  
aluminum combination



**GAVA 872**  
DecorGlass 'Harmony',  
alu kombináció/  
aluminum combination



**GAVA hpl**

GAVA 730  
GAVA 740  
GAVA 870  
78-79



**GAVA 892**  
eiche dunkel, DecorGlass 'Linea',  
alu kombináció / aluminum combination



**GAVA 811**  
DecorGlass 'Carnival',  
alu kombináció/  
aluminum combination



**GAVA 811**  
DecorGlass 'Arena',  
alu kombináció/  
aluminum combination



**GAVA 811**  
aranytölgy, golden Oak  
DecorGlass 'Figaro',  
alu kombináció/  
aluminum combination



**GAVA 811**  
eiche dunkel,  
alu kombináció/  
aluminum combination

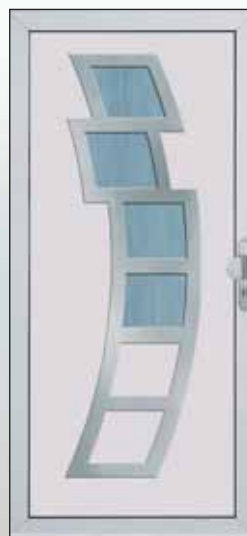

**GAVA 891**  
alu kombináció /  
aluminum combination

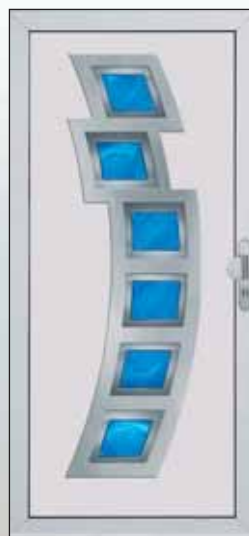

**GAVA 892**  
DecorGlass 'Plane',  
alu kombináció /  
aluminum combination



**GAVA 893**  
nussbaum,  
alu kombináció /  
aluminum combination



**GAVA 800**  
eiche dunkel,  
alu kombináció /  
aluminum combination



**GAVA 801**  
DecorGlass 'Bird',  
alu kombináció /  
aluminum combination



**GAVA 811**  
nussbaum, DecorGlass 'Game',  
alu kombináció / aluminum combination

**GAVA 811**

**GAVA hpl**

GAVA 890  
GAVA 800  
GAVA 810  
80-81



**GAVA 916**  
nussbaum



**GAVA 912a, 912a/2**  
alu kombináció /  
aluminum combination



**GAVA 912**  
aranytölgy /  
golden Oak

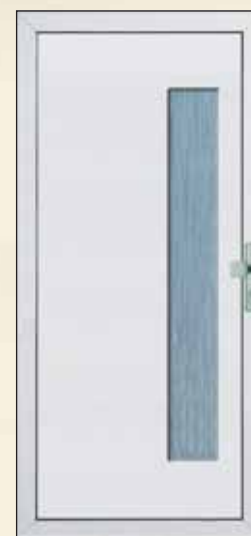

**GAVA 913**



**GAVA 913a**  
alu kombináció /  
aluminum combination



**GAVA 916 916/2**  
aranytölgy /  
golden Oak



**GAVA 964a**  
eiche dunkel,  
alu kombináció /  
aluminum combination



**964a/2 GAVA 964**  
eiche dunkel,  
nussbaum



**GAVA 964b**  
alu kombináció /  
aluminum combination



GAVA 941



GAVA 961a  
alu kombináció /  
aluminum combination



GAVA 961  
nussbaum



GAVA 939  
aranytölgy / golden Oak



**GAVA 917**  
aranytölgy /  
golden Oak

**917/2**  
aranytölgy /  
golden Oak

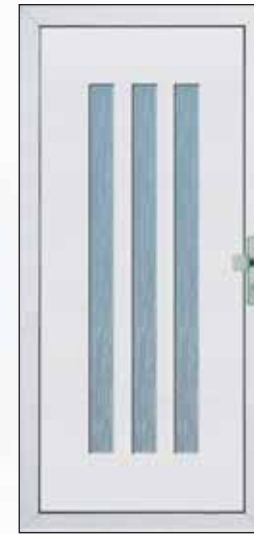

**GAVA 918**



**GAVA 918a**  
alu kombináció /  
aluminum combination

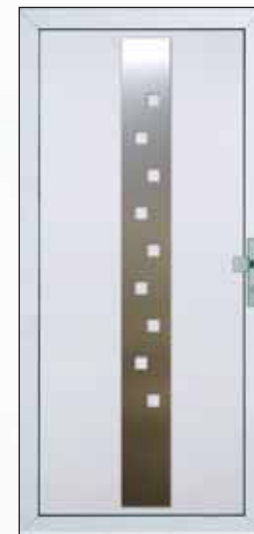

**GAVA 950**  
alu kombináció /  
aluminum combination

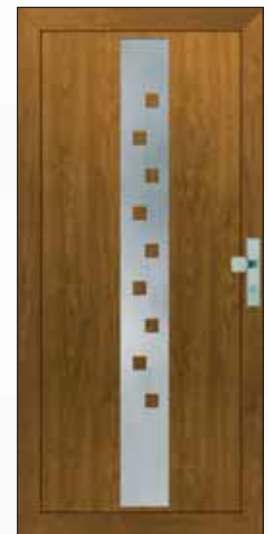

**GAVA 950**  
aranytölgy, golden Oak  
alu kombináció /  
aluminum combination



### GAVA 949

alu kombináció fatörzs üveggel /  
aluminum combination  
tree with glass



### GAVA 956

aranytölgy, golden Oak  
alu kombináció fatörzs üveggel /  
aluminum combination  
tree with glass



GAVA 951  
eiche dunkel



### GAVA 951



### GAVA 955

alu kombináció fatörzs  
üveggel /  
aluminum combination  
tree with glass

**GAVA hpl**

GAVA 900  
újdonosság  
novelty

84-85

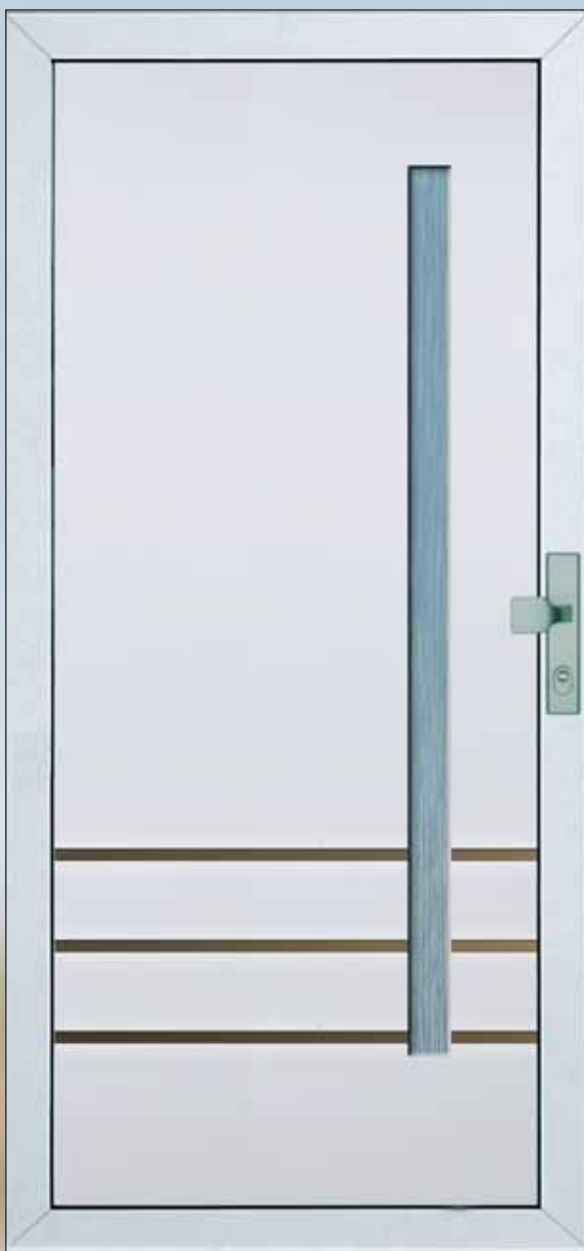

**GAVA 919**  
alu intarzia /  
aluminum inlay

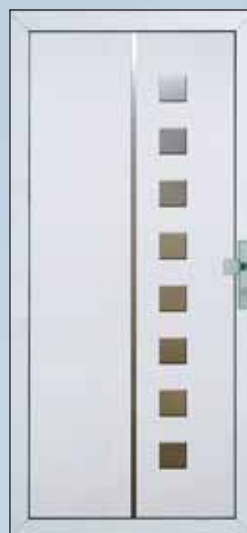

**GAVA 945**  
alu intarzia, alu  
kombináció /  
aluminum inlay,  
aluminum combination



**GAVA 945**  
eiche dunkel,  
alu intarzia, alu kombináció /  
aluminum inlay,  
aluminum combination



**GAVA 919**  
eiche dunkel,  
alu intarzia /  
aluminum inlay

**GAVA 919/2**  
eiche dunkel,  
alu intarzia /  
aluminum inlay



**GAVA 947**  
nussbaum,  
alu intarzia, fatörzs üveggel /  
aluminum inlay, tree with glass



**GAVA 946**  
aranytölgy, golden Oak  
alu intarzia, fatörzs üveggel /  
aluminum inlay, tree with glass





### GAVA 929a

eiche dunkel,  
alu kombináció, fatörzs üveggel /  
aluminum combination tree with glass

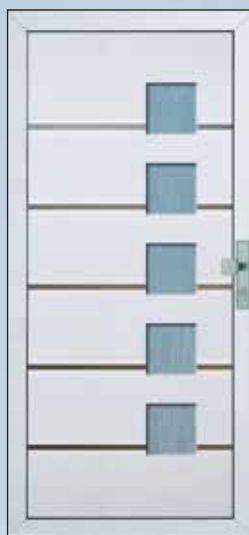

### GAVA 928

alu intarzia, fatörzs  
üveggel / aluminum  
inlay, tree with glass

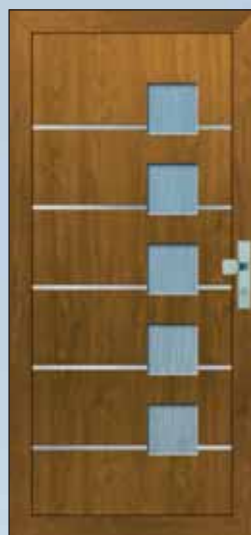

### GAVA 928

aranytölgy, golden Oak  
alu intarzia, fatörzs  
üveggel / aluminum inlay,  
tree with glass



### GAVA 926

nussbaum,  
fatörzs üveggel /  
tree with glass





**GAVA 900** - Részletes kép alumínium kombinációról és az alumínium intarziáról

- Alu kombináció: HPL felületén ráragasztott eloxált alumínium részek (pl.: négyzetek, keret, vonal, csíkok)
- Alu intarzia: eloxált alumínium csíkok besüllyesztve a HPL anyagába, egy síkban

**GAVA 900** - Detailed images of aluminum combination and aluminum inlay

- Alu combination: HPL surface of anodized aluminum parts are glued (boxes, frames, lines, stripes)
- Alu inlay: Anodized aluminum strips embedded in the HPL material of a plane



**GAVA 900**  
alu intarzia, alu kombináció /  
aluminum inlay,  
aluminum combination



**GAVA 900** nussbaum,  
alu intarzia, alu kombináció /  
aluminum inlay,  
aluminum combination

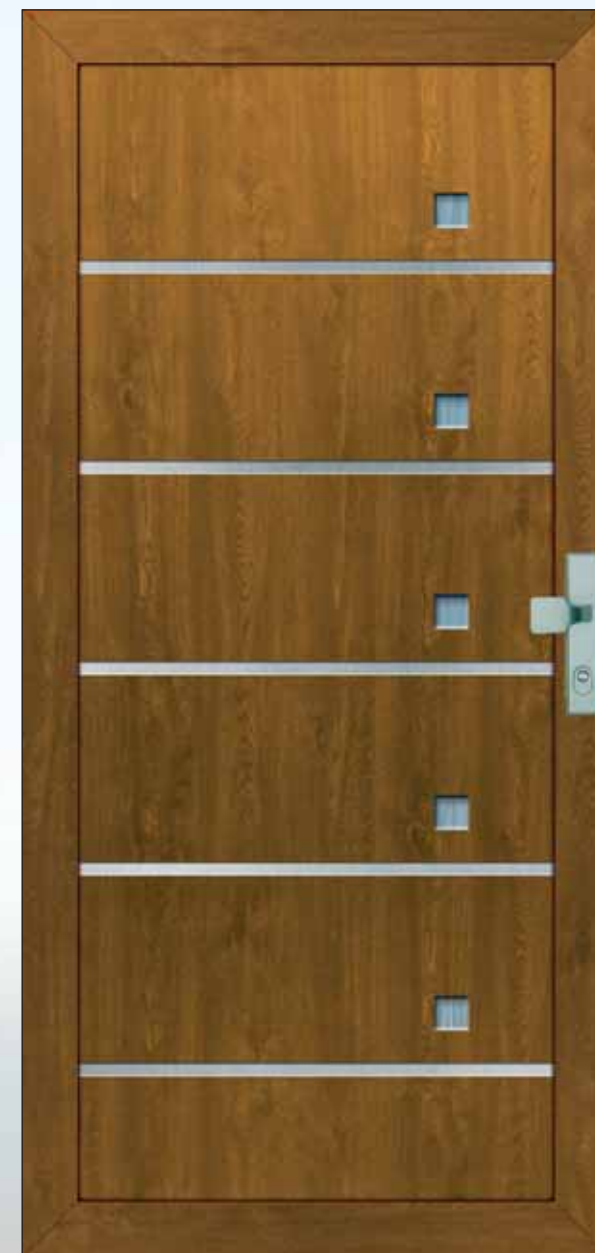

**GAVA 901** aranytölgy, golden Oak  
alu intarzia, fatörzs üveggel /  
aluminum inlay, tree with glass

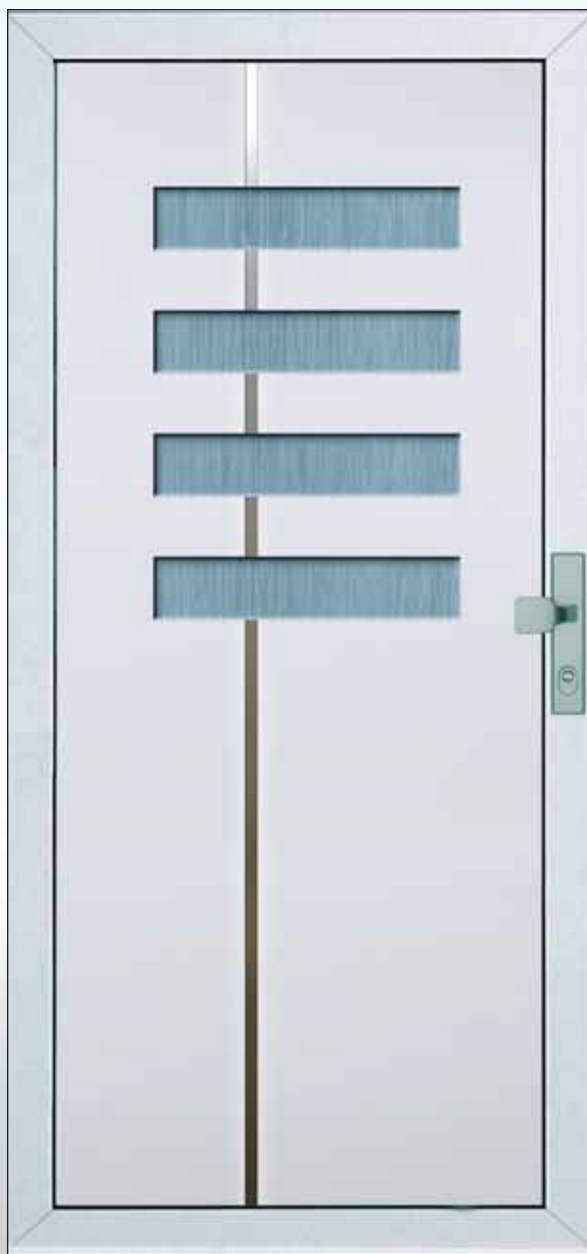

**GAVA 948**  
alu intarzia, fatörzs üveggel /  
aluminum inlay, tree with glass

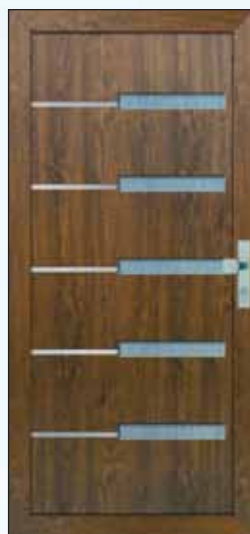

**GAVA 953**  
nussbaum,  
alu intarzia, fatörzs üveggel /  
aluminum inlay, tree with glass

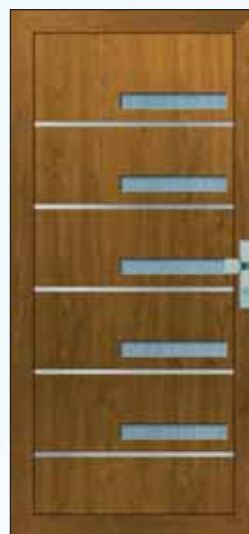

**GAVA 954**  
aranytölgy, golden Oak  
alu intarzia, fatörzs üveggel /  
aluminum inlay, tree with glass



**GAVA 952**  
eiche dunkel,  
alu intarzia, fatörzs üveggel /  
aluminum inlay, tree with glass



## HPL panelek színválasztéka / HPL panels for color selection



<b>Palisander</b> Renolit 8875 05	<b>Mooreiche</b> Renolit 3167 004	<b>Sapeli</b> Renolit 2065 021	<b>Mahagón</b> Renolit 2097 013	<b>Macore</b> Renolit 3162 002	<b>Nussbaum</b> Renolit 2178 007	<b>Streifendouglas</b> Renolit 3152 009	<b>Noce Sorrento balsamico</b> Hornschuch F 439-3042	<b>Cherry amaretto</b> Hornschuch F 425-2043	<b>Nevada</b> Renolit 2167 010	<b>Walnuss Amaretto</b> 436 3058
--------------------------------------	--------------------------------------	-----------------------------------	------------------------------------	-----------------------------------	-------------------------------------	--	--	--	-----------------------------------	---



<b>Staufereiche terra</b> Hornschuch F 436-2035	<b>Eiche dunkel</b> Renolit 2052 089	<b>Eiche rustikal</b> Renolit 3149 008	<b>Eiche jalt</b> Renolit 3156003	<b>Aranytölgy Golden Oak</b> Renolit 2178 001	<b>Eiche hell</b> Renolit 2052 090	<b>Eiche natur</b> Renolit 3118 076	<b>Irish oak</b> Renolit 3211 005	<b>Siena rosso</b> Renolit 492 33	<b>Siena noce</b> Renolit 492 37	<b>Antrazit Smooth</b> 436 7003
---	---	---	--------------------------------------	--	---------------------------------------	--	--------------------------------------	--------------------------------------	-------------------------------------	------------------------------------



**Canadian**  
Renolit 491 95

**Oregon 3**  
Renolit 2115 008

**Oregon 4**  
Renolit 1192 001

**Winchester**  
Renolit 492 40

**Sierra**  
Renolit 2167 009

**Birke rose**  
Hornschuch  
F 436-3031

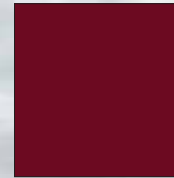

**weinrot**  
3005 05

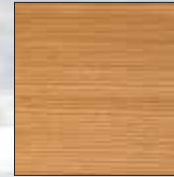

**Bergkiefer**  
3069 041



**Dunkelrot**  
3081 05

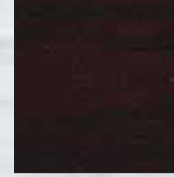

**Black Cherry**  
3202 001

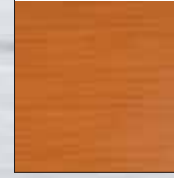

**Indian**  
49198



**Dark Green**  
612505

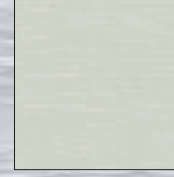

**lichtgrau**  
725105



**soft cherry**  
3214009



**noce sorrento  
natur**  
4363041



**walnuss  
kolonial**  
4363062



**titanium**  
4367022

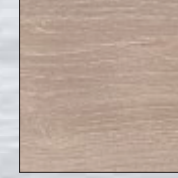

**Hornschuch**  
F456-4081

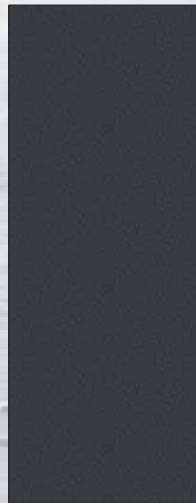

**Anthrazitgrau**  
Renolit 7016 05



**Stahlblau**  
Renolit 515005

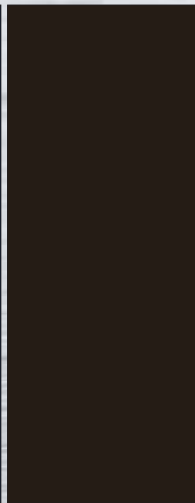

**Schwarzbraun**  
Renolit 8518 05

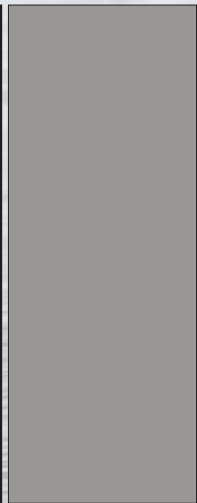

**Grau**  
Renolit 7155 05



**Metbursch  
Aluminium**  
Hornschuch  
F436-1001



**Tabasco Teak**  
Renolit 2222 004

## **GAVA HPL** (High Pressure Laminated)

### Technikai adatok HPL panelekhez

HPL – gyanta alapú ajtópanel lap. Ezek az ajtólapok erősebbek, stabilabbak és széles színválasztékban kaphatók.

#### Fehér HPL színválaszték:

- HPL Weiss (standard fehér)
- HPL Salamander

#### Merevítések:

- XPS
- XPS+acéllemez

Maximális méretek: 900mm × 2150mm

#### Ajtópanelek vastagsága:

- Standard vastagság: 24mm, 34mm, 36mm, 44mm
- Egyedi vastagságok: 30mm, 32mm, 40mm, ....stb., egyeztetés alapján gyárthatók

#### Hőátbocsátási tényezők:

- 24 mm vastag: XPS Styrodur 24  $u= 1,04 \text{ W.m}^{-2}.\text{K}^{-1}$
- 24 mm vastag: XPS Styrodur 24 + acél lemez  $u= 1,26 \text{ W.m}^{-2}.\text{K}^{-1}$
- 34 mm vastag: XPS Styrodur 34  $u= 0,89 \text{ W.m}^{-2}.\text{K}^{-1}$
- 36 mm vastag: XPS Styrodur 36  $u= 0,85 \text{ W.m}^{-2}.\text{K}^{-1}$
- 44 mm vastag: XPS Styrodur 44  $u= 0,71 \text{ W.m}^{-2}.\text{K}^{-1}$

- Alu kombináció: HPL felületén ráragasztott eloxált alumínium részek (pl.: négyzetek, keret, vonal, csíkok)
- Alu intarzia: eloxált alumínium csíkok besüllyesztve a HPL anyagába, 1 síkban

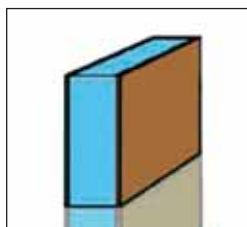

HPL

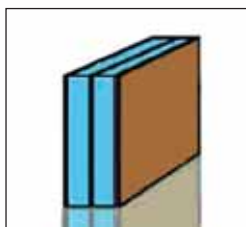

HPL+acéllemez

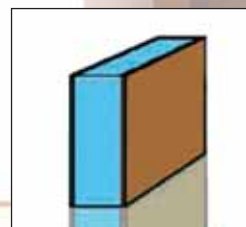

HPL

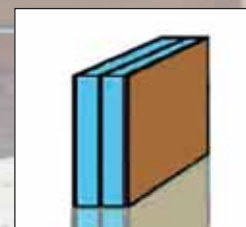

HPL+steel

## **GAVA HPL** (High Pressure Laminated)

### Technical data of HPL panels:

HPL – resin Door tab. These doors are stronger, more stable and wide range of colors available.

#### HPL white colors:

- HPL Weiss (standard white)
- HPL Salamander

#### Fixings:

- XPS
- XPS+steel

Maximal dimensions: 900mm × 2150mm

#### Door panel thickness:

- Standard panel thickness: 24mm, 34mm, 36mm, 44mm
- thicknesses of individual: 30mm, 32mm, 40mm, .... arrangement can be produced

#### Heat transfer coefficient:

- 24 mm: XPS Styrodur 24  $u= 1,04 \text{ W.m}^{-2}.\text{K}^{-1}$
- 24 mm: XPS Styrodur 24 + steel  $u= 1,26 \text{ W.m}^{-2}.\text{K}^{-1}$
- 34 mm: XPS Styrodur 34  $u= 0,89 \text{ W.m}^{-2}.\text{K}^{-1}$
- 36 mm: XPS Styrodur 36  $u= 0,85 \text{ W.m}^{-2}.\text{K}^{-1}$
- 44 mm: XPS Styrodur 44  $u= 0,71 \text{ W.m}^{-2}.\text{K}^{-1}$

- Aluminum combination: HPL surface of anodized aluminum parts are glued (boxes, frames, lines, stripes,...)
- Aluminum inlay: anodized aluminum strips embedded in the HPL material of one plane

## Kiegészítők / Accessories



oroszlánfejes,  
nagy, bronz /  
lion head,  
large, bronze



oroszlánfejes,  
kicsi, bronz /  
lion head,  
small, bronze



oroszlánfejes,  
nagy, réz /  
lion head,  
large, copper



oroszlánfejes,  
kicsi, réz /  
lion head,  
small, copper



urna, réz /  
urn, copper



kör, bronz /  
circle, bronze



kör, réz /  
circle, copper



ovál, bronz /  
oval, bronze



ovál, réz /  
oval, copper



kitekintő /  
door viewer  
ezüst / silver  
20-35 mm  
31-55 mm



kitekintő /  
door viewer  
arany / gold  
20-35 mm  
31-55 mm



alumínium levélbedobó, ezüst /  
aluminum letter plate, silver



arany színű levélbedobó /  
gold-colored letter plate



alumínium levélbedobó, fehér /  
aluminum letter plate, white



levélbedobó műanyag kerettel, ezüst /  
face-off plastic letter plate, silver



levélbedobó műanyag kerettel, arany /  
face-off plastic letter plate, gold



levélbedobó műanyag kerettel, fehér /  
face-off plastic letter plate, white

Homokfúvott üveg minták /  
Frosted glass samples

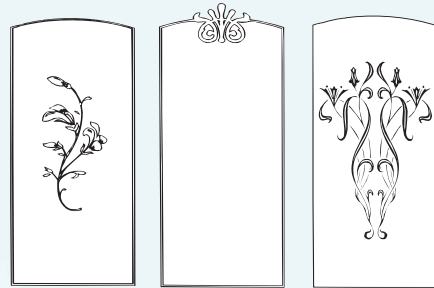

001

003

007

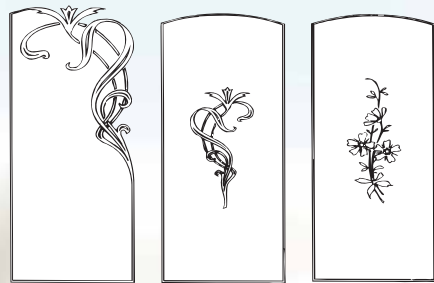

007J

007S

012

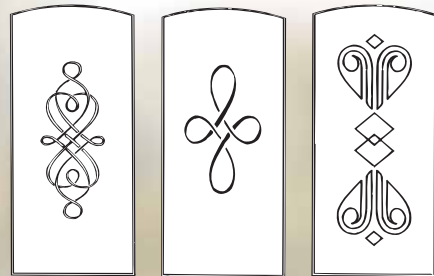

018

018D

023K

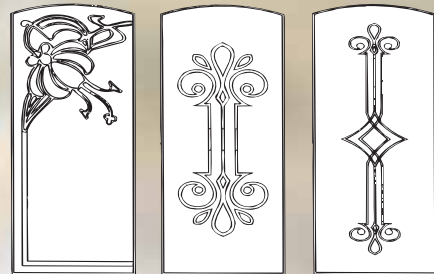

024D

026D

026F

FussingGlass



'Jeseň'



'Hviezdny prach'



'Avalon'



'Eden'



'Vlčie maky'

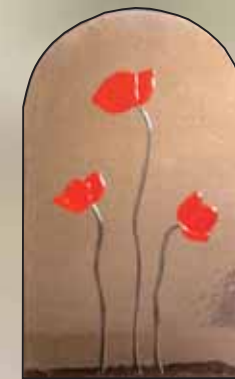

'Trojruža'

Homokfúvott üveg minták /  
Frosted glass samples



homokfúvott vonalak/lines



homokfúvott négyzetek/ squares

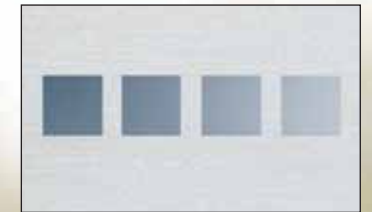

homokfúvott üveg átlátszó négyzetek/ transparent boxes



homokfúvott négyzetek/ squares

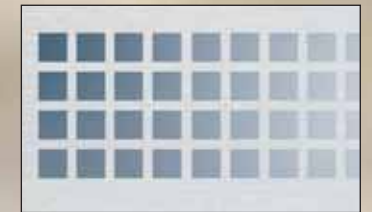

homokfúvott üveg átlátszó négyzetek/  
frosted glass transparent blocks





## Katedrál üvegválaszték / Cathedral glass range



Altdeutsch K biely

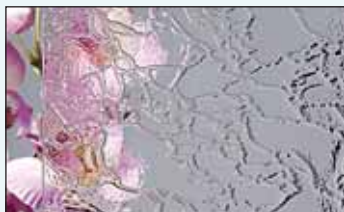

Delta číra



Madera



Altdeutsch K bronz

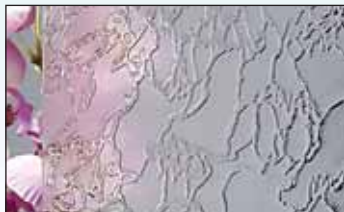

Delta matná



Cincila



Bronz fatörzs/Bronze tree



Fehér fatörzs/ White tree



Silvit



Crepi



Katedral MIN

## Feláras üvegválaszték / Surcharge glass range

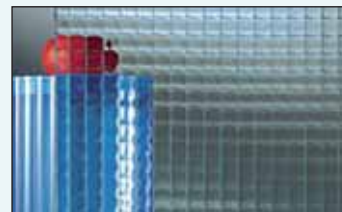

Drôto-sklo



Master Lens



Flutes M



Master Point



Matelux clearvison



Master Ray



Master Carré



Square



Master Ligne



Conex

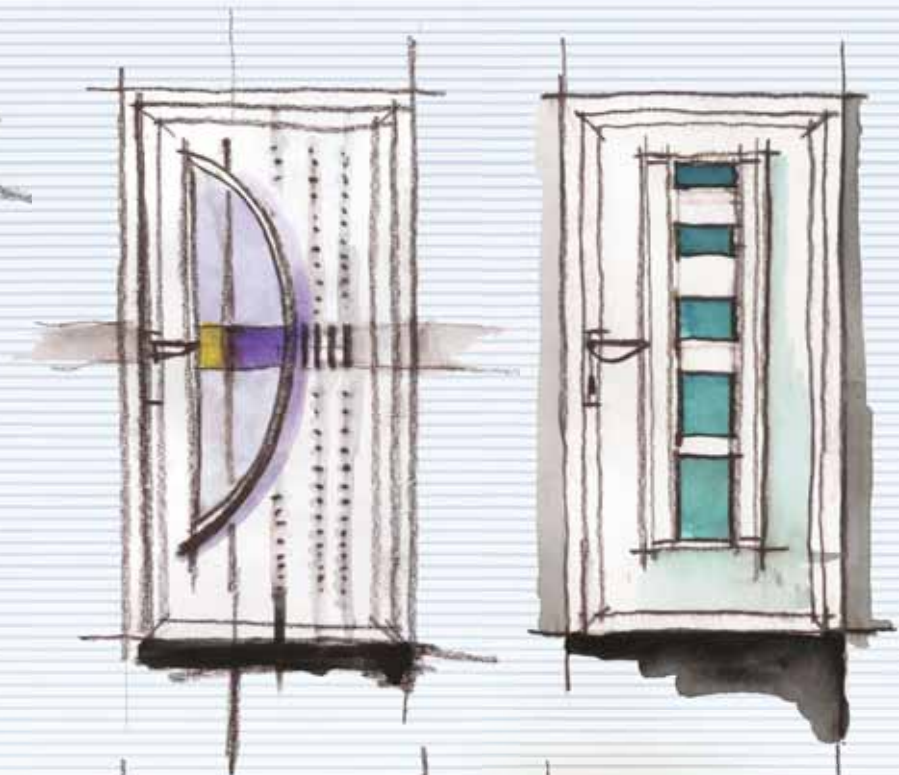

az ötlettől  
...a részletekig

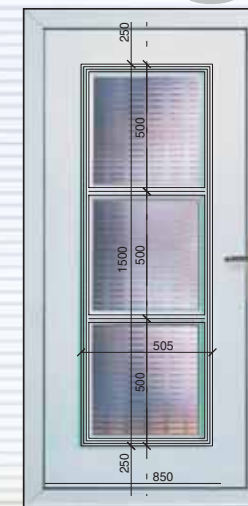
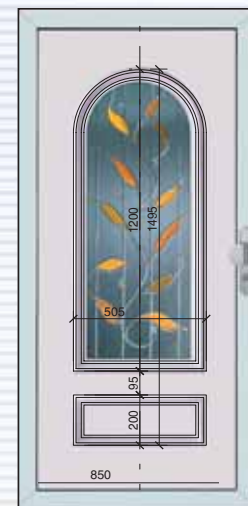
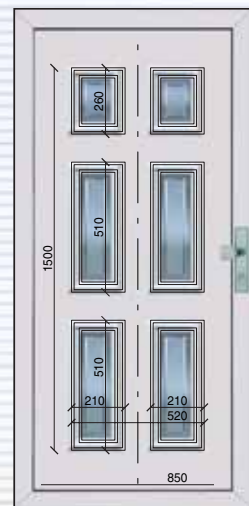
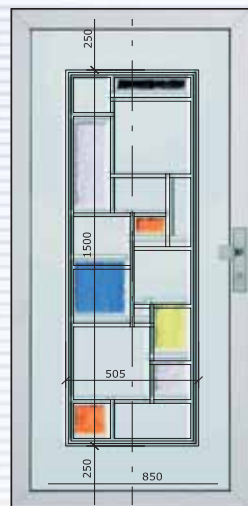
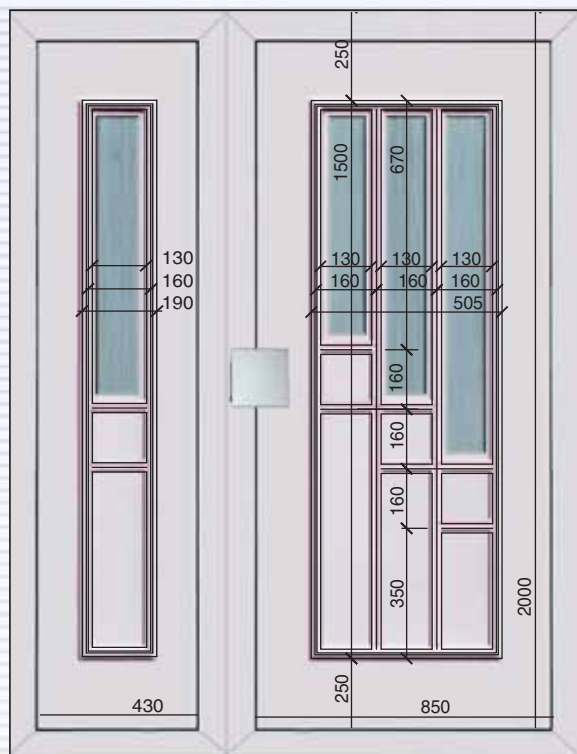

From sketch  
...to detail

AJTÓPANELEK MÉRETEZÉSEI/  
Dimensioning DOOR PANELS

**GAVA plast**

96-97

AJTÓBETÉTEK MŰANYAG ÉS ALUMÍNÍUM PROFILRENDSZEREKHEZ  
DOOR-INFILL PANELS FOR ALUMINIUM & PLASTIC SYSTEMS

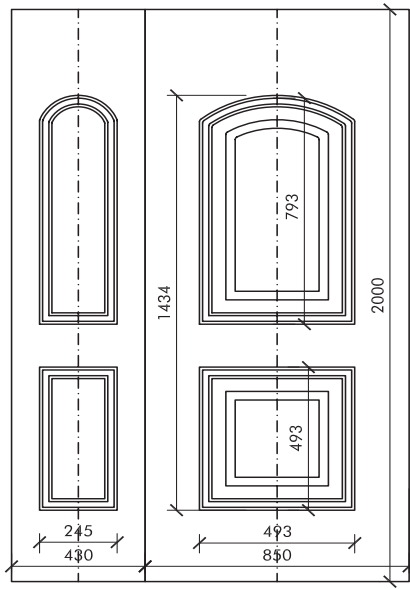

Gava 010

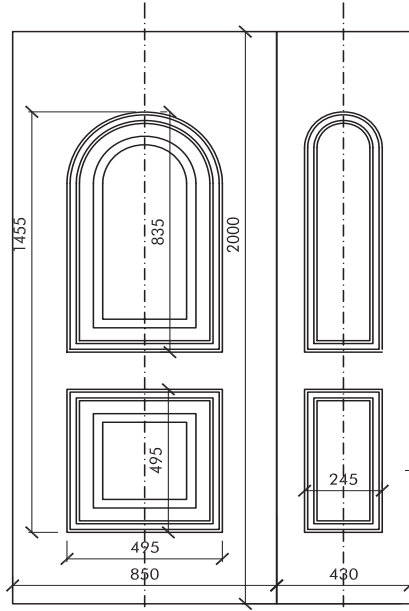

Gava 020

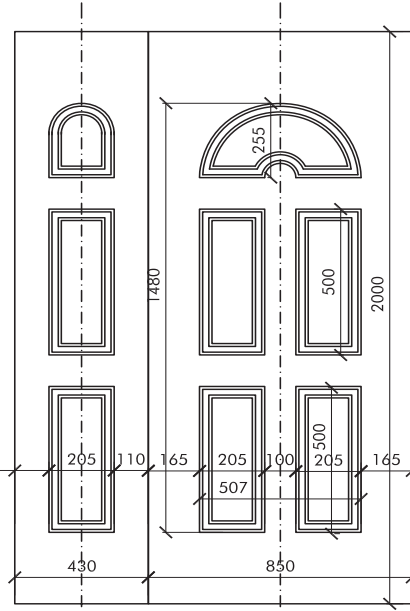

Gava 030

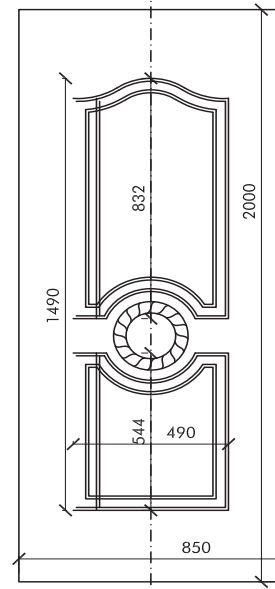

Gava 040

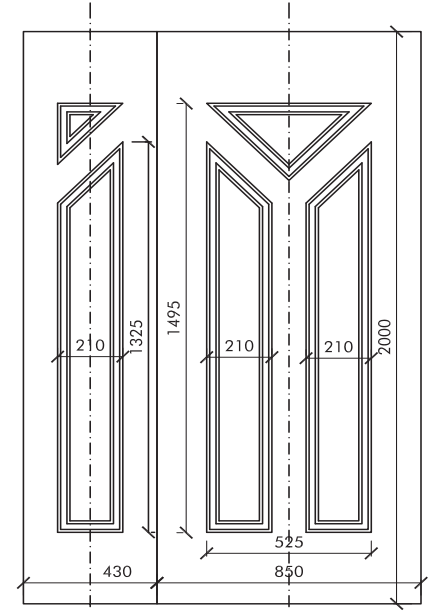

Gava 050

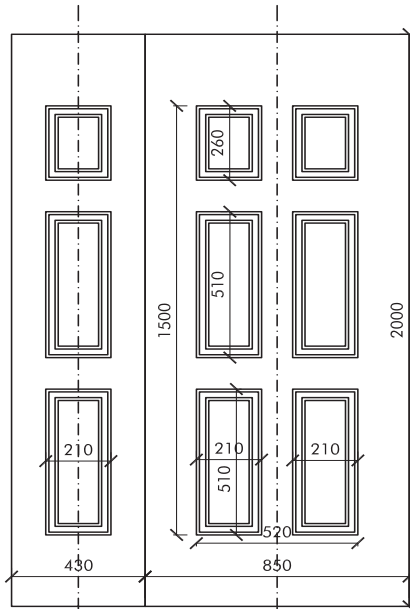

Gava 060

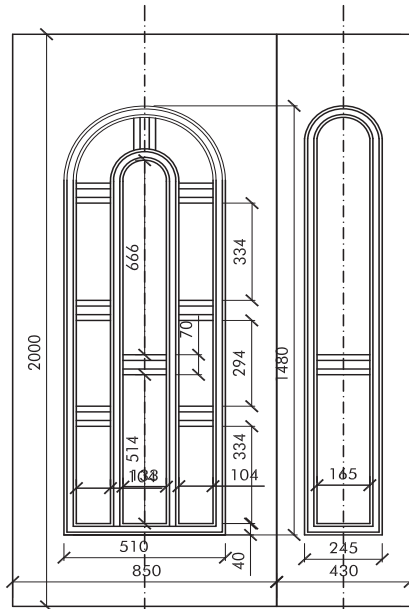

Gava 070

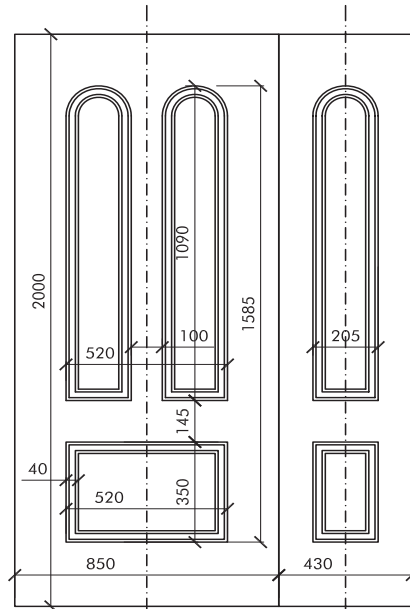

Gava 080

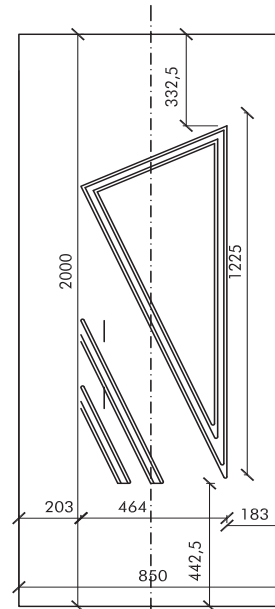

Gava 090

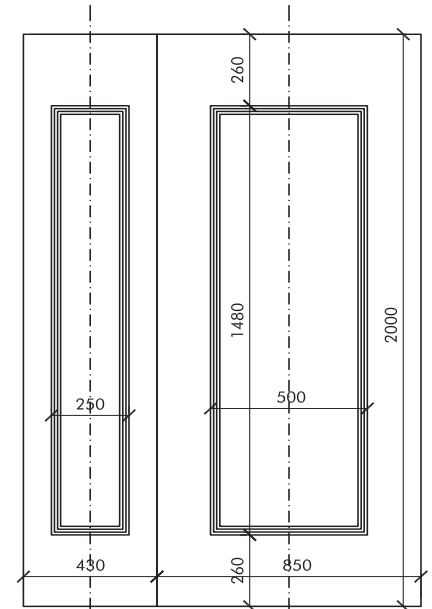

Gava 100

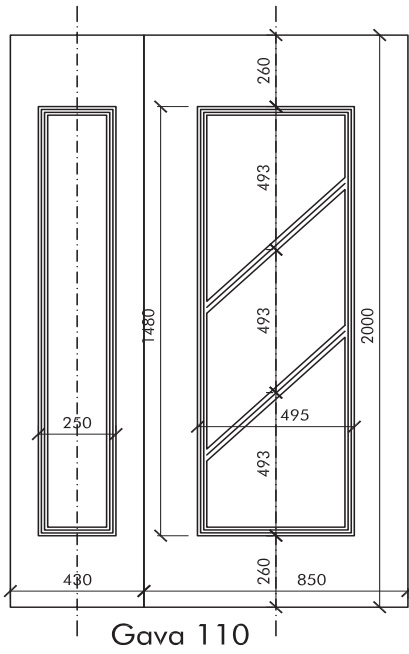

Gava 110

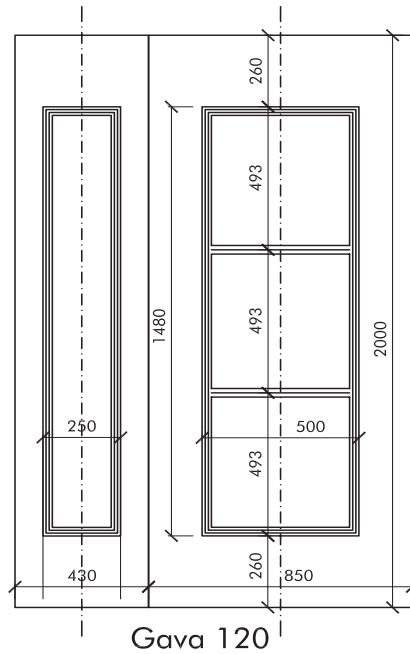

Gava 120

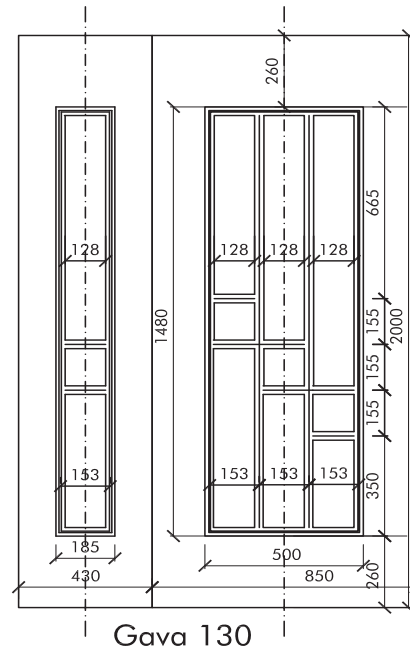

Gava 130

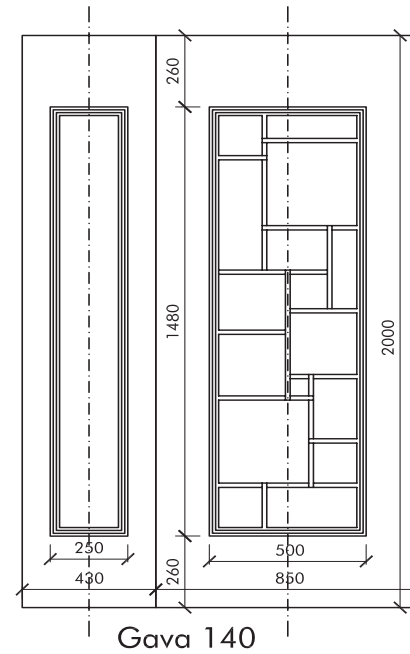

Gava 140

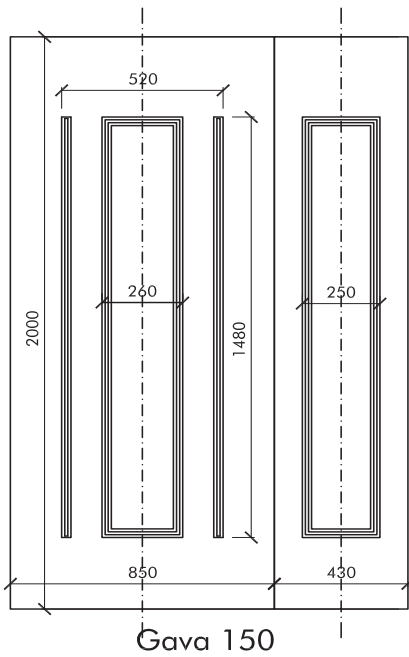

Gava 150

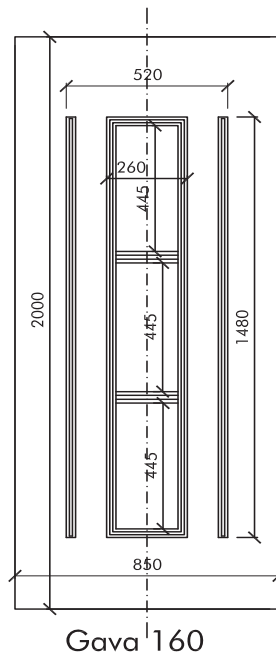

Gava 160

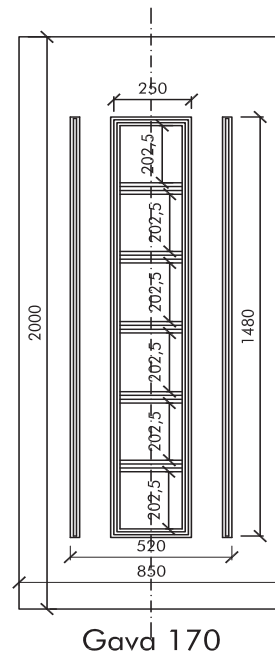

Gava 170

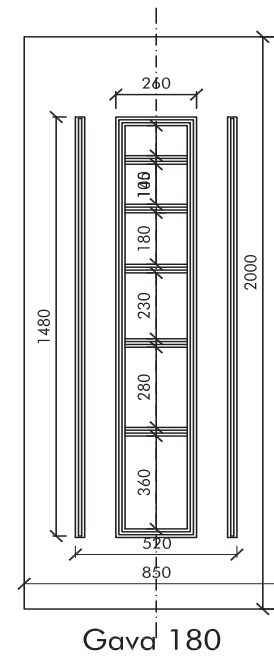

Gava 180

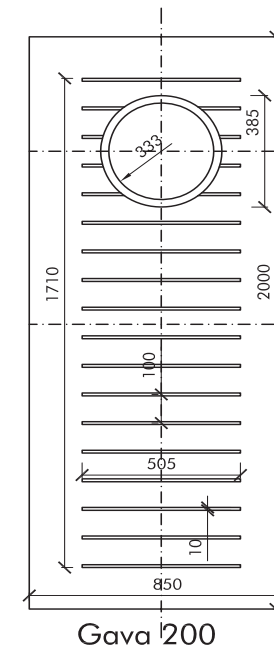

Gava 200

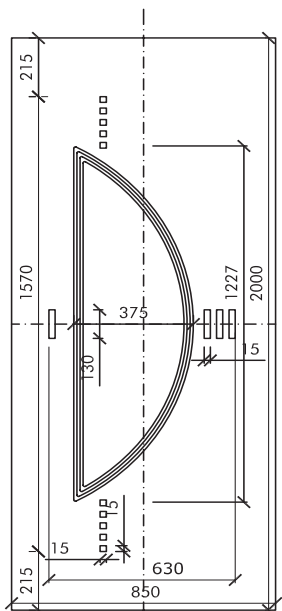

Gava 210

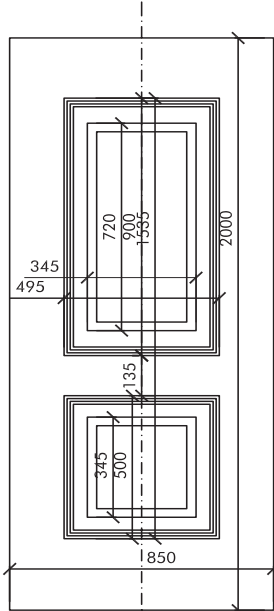

Gava 220

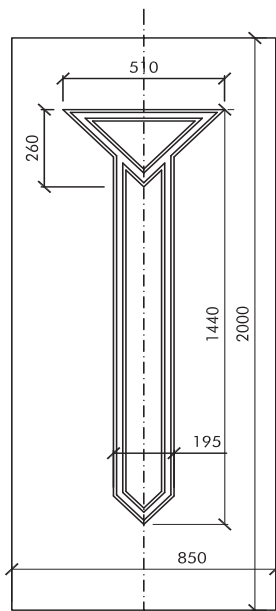

Gava 230

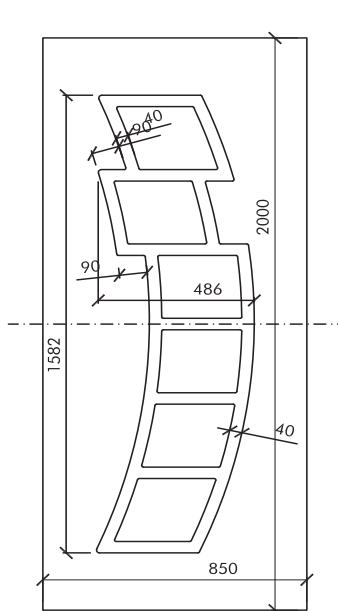

Gava 290

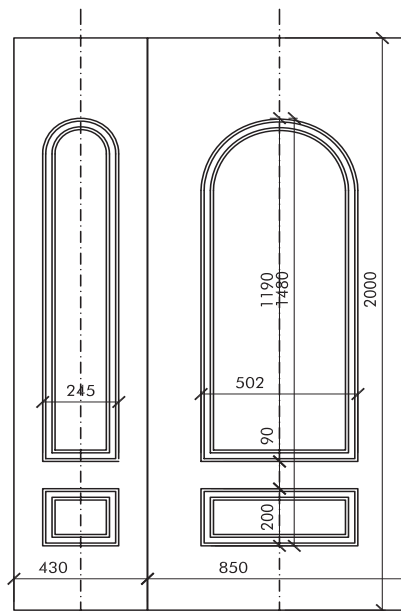

Gava 240

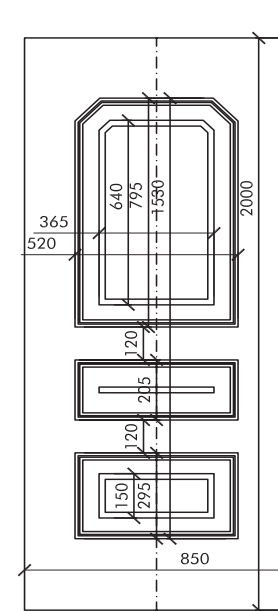

Gava 250

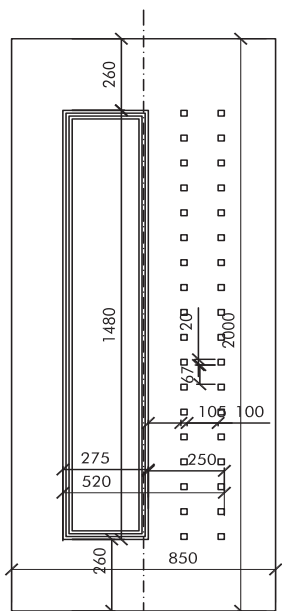

Gava 260

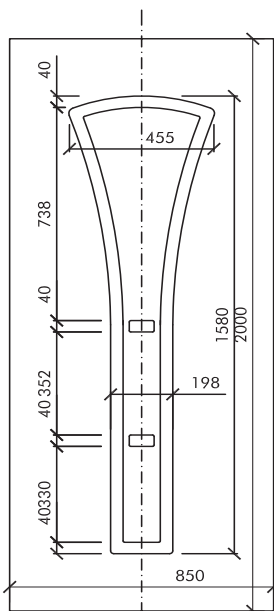

Gava 270

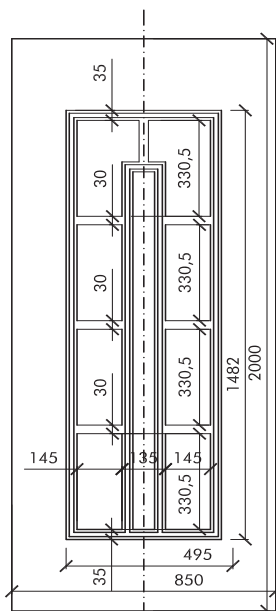

Gava 280

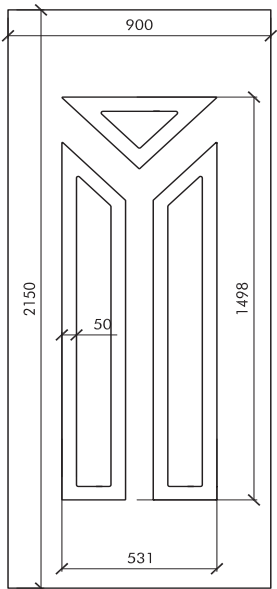

Gava 650

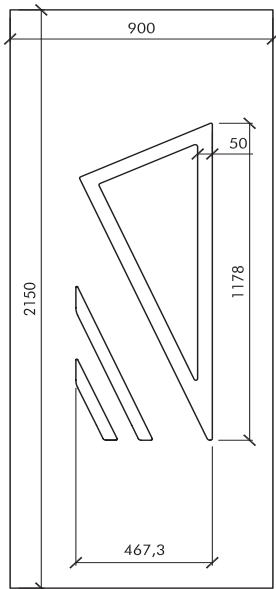

Gava 691

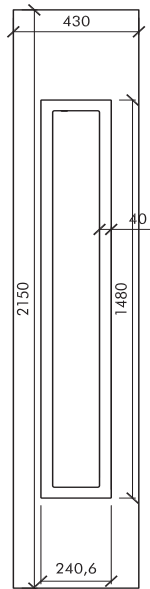

701/2

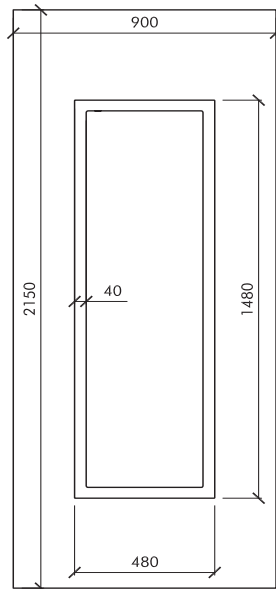

Gava 701

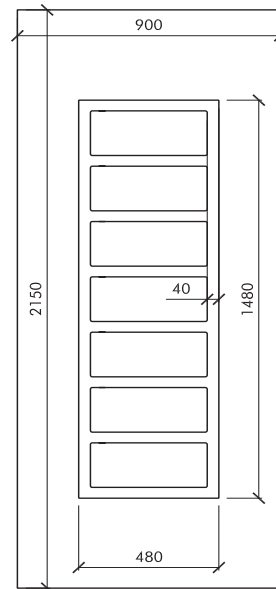

Gava 702

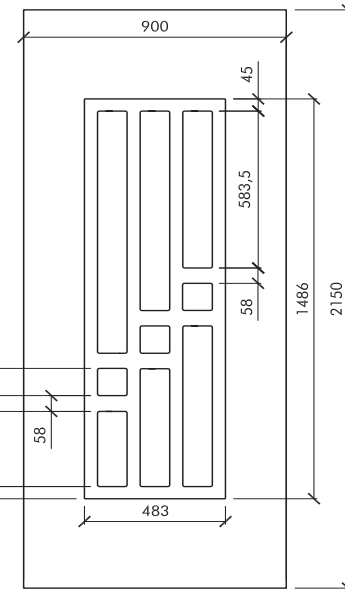

Gava 732

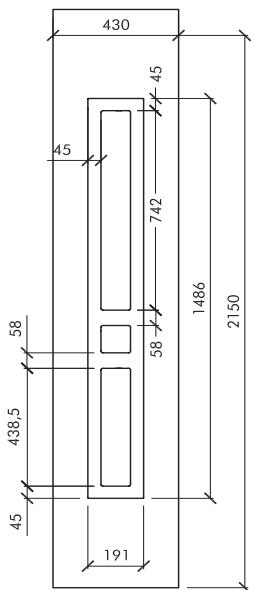

732/2

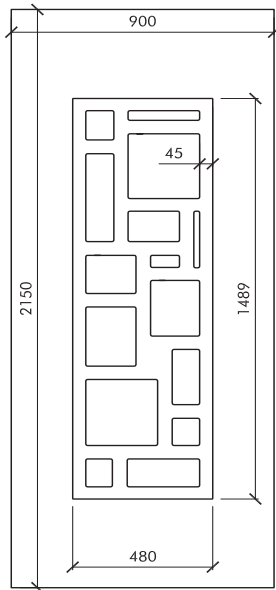

Gava 740

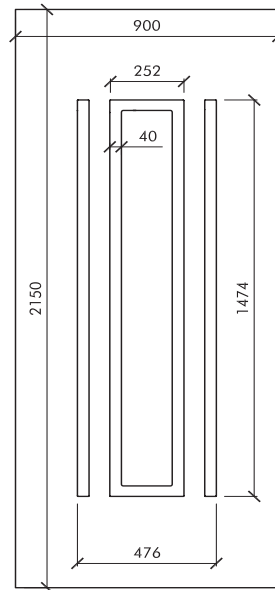

Gava 651

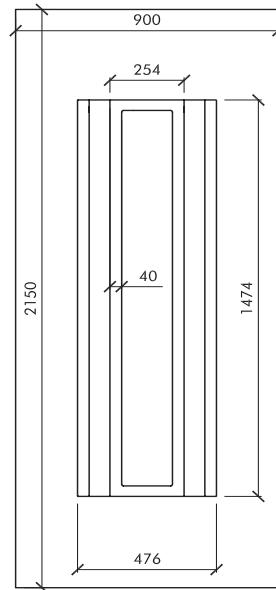

Gava 752

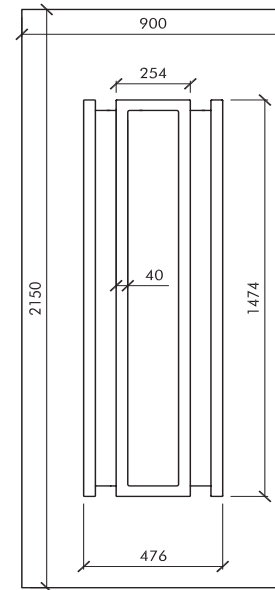

Gava 753

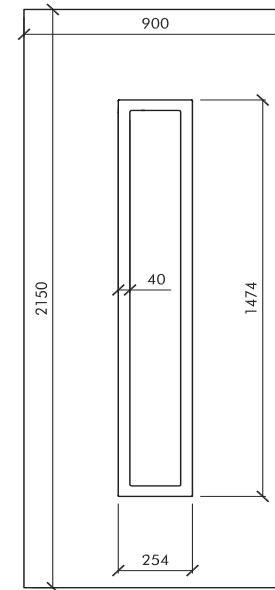

Gava 754

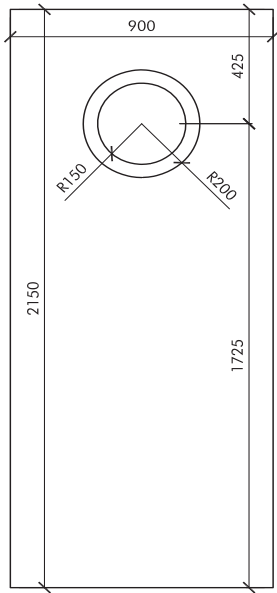

Gava 800

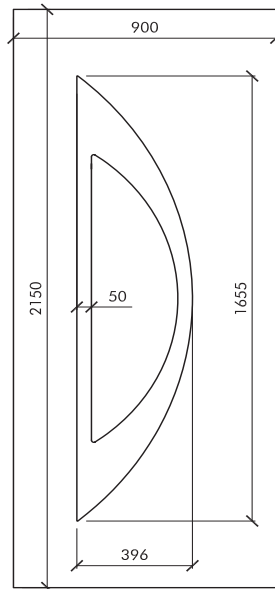

Gava 811

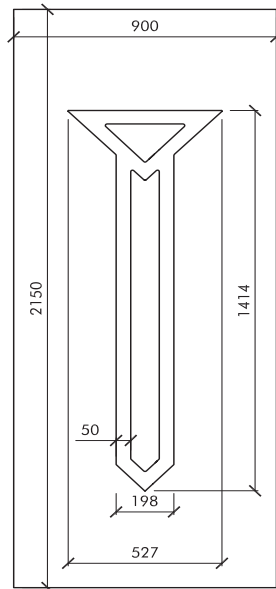

Gava 832

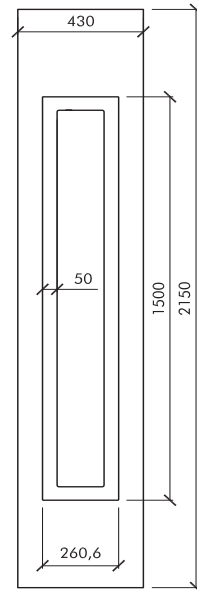

860/2

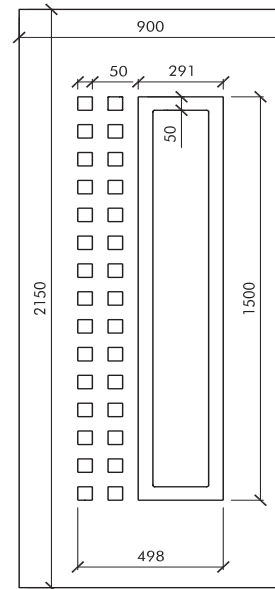

Gava 860

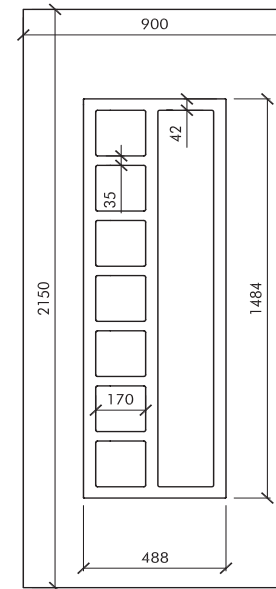

Gava 862

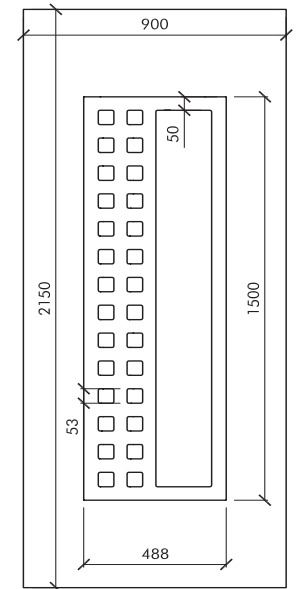

Gava 863

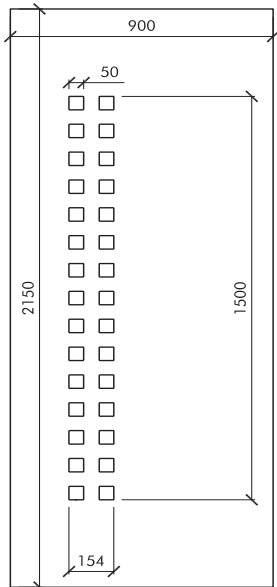

Gava 864

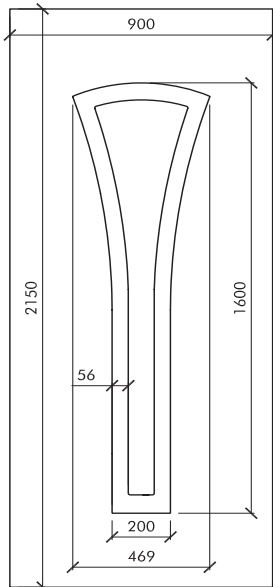

Gava 871

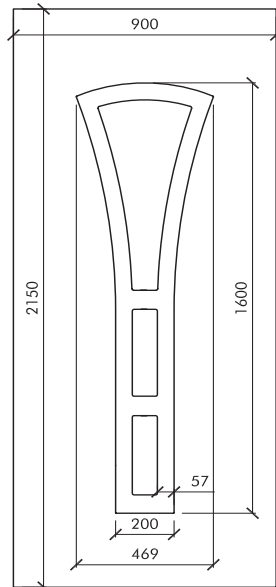

Gava 873

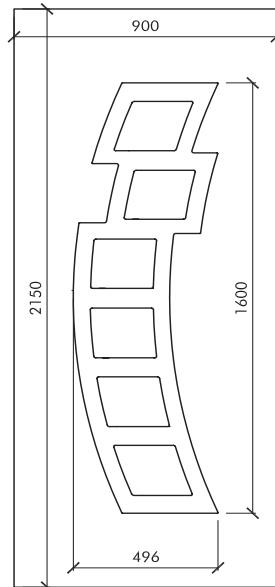

Gava 892

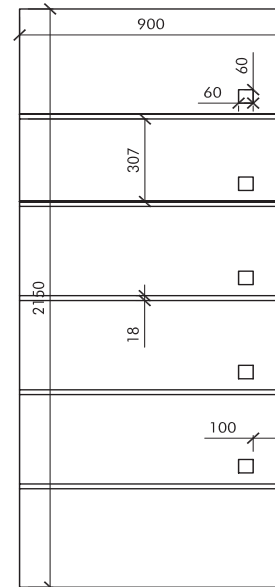

Gava 900

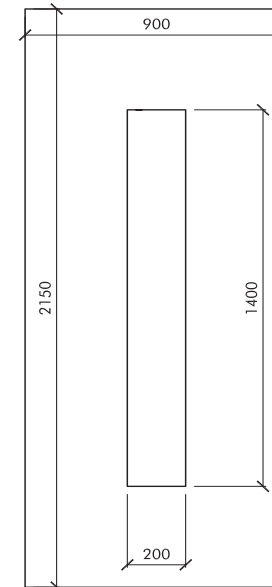

Gava 912

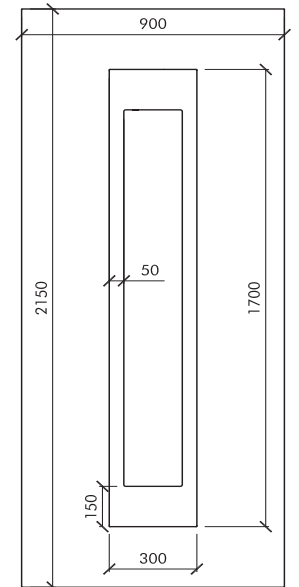

Gava 912a



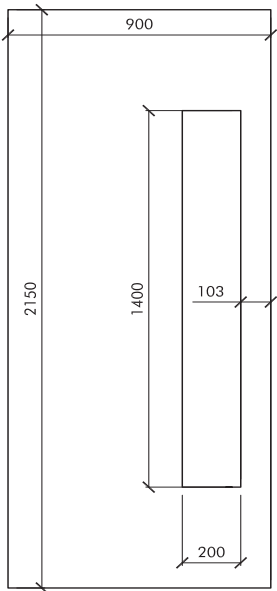

Gava 913

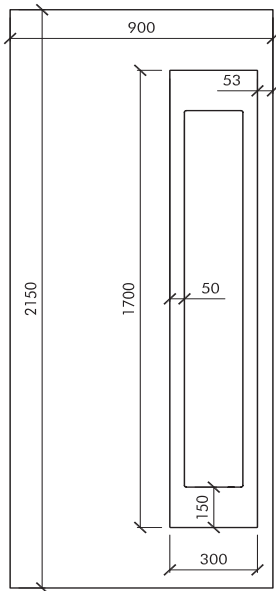

Gava 913a

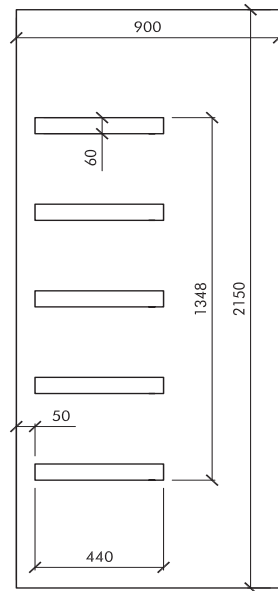

Gava 916

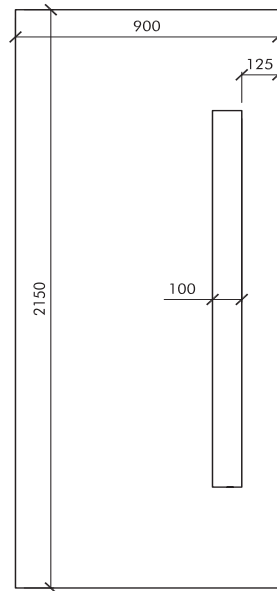

Gava 917

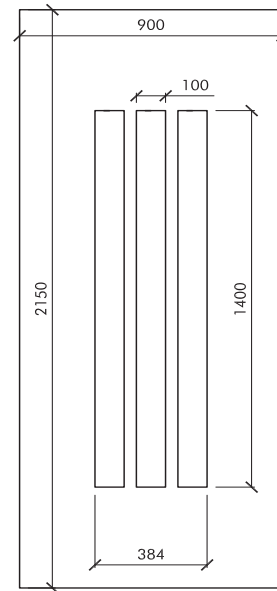

Gava 918

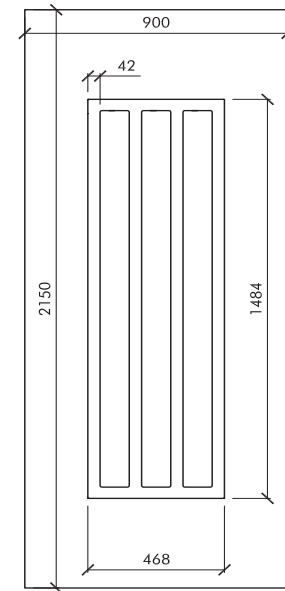

Gava 918a

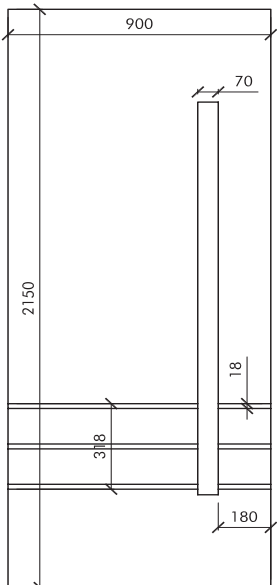

Gava 919

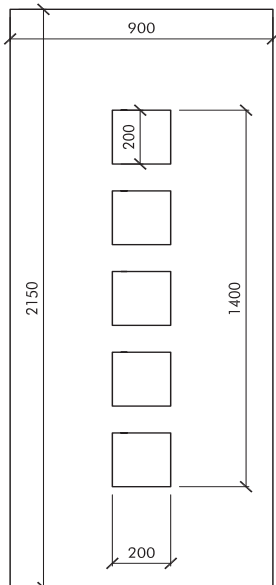

Gava 926

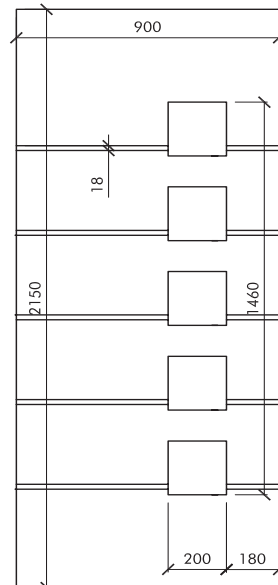

Gava 928

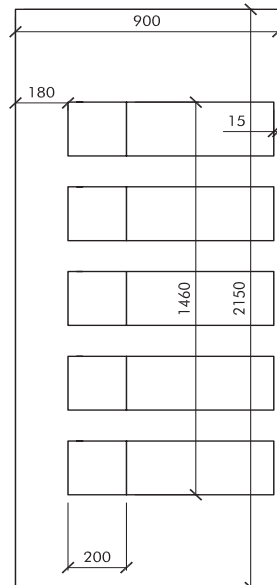

Gava 929a

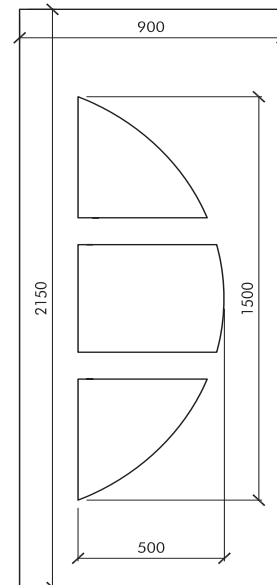

Gava 939

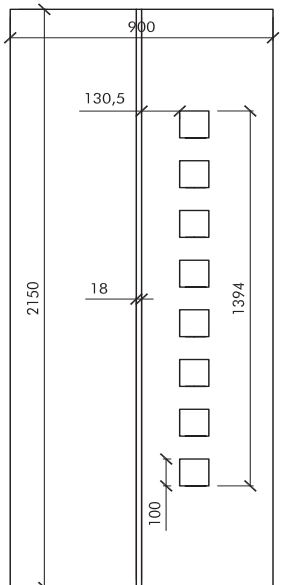

Gava 946

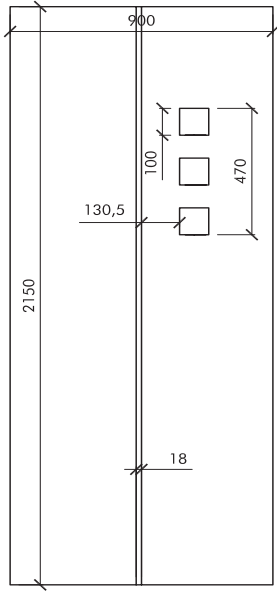

Gava 947

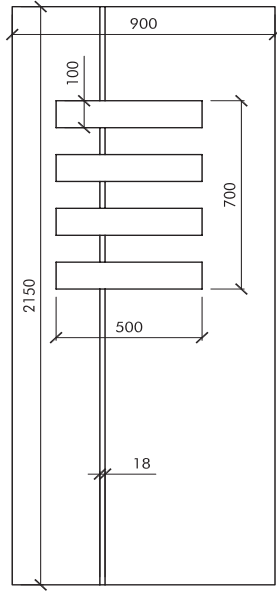

Gava 948

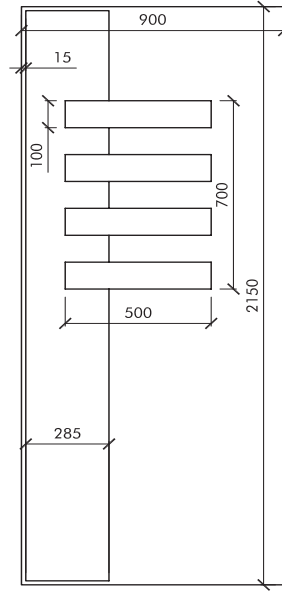

Gava 949

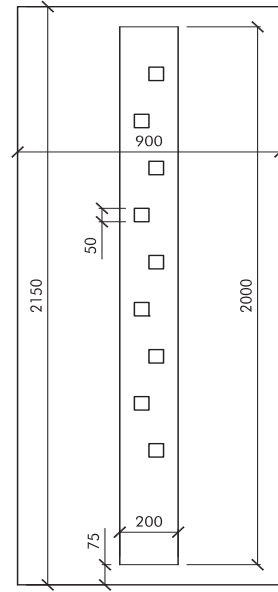

Gava 950

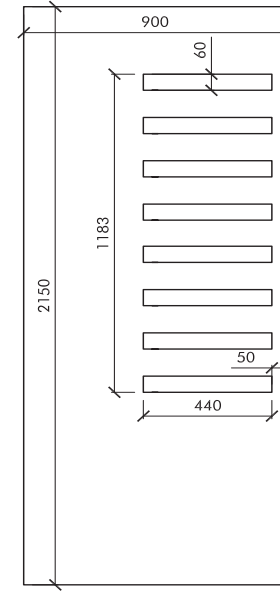

Gava 951

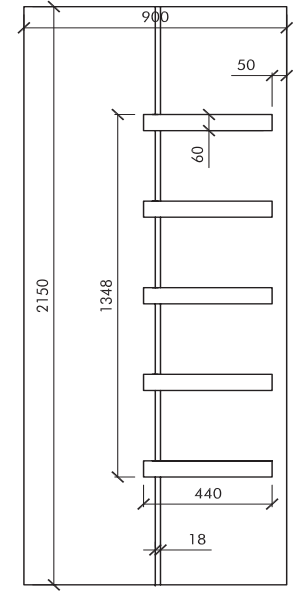

Gava 952

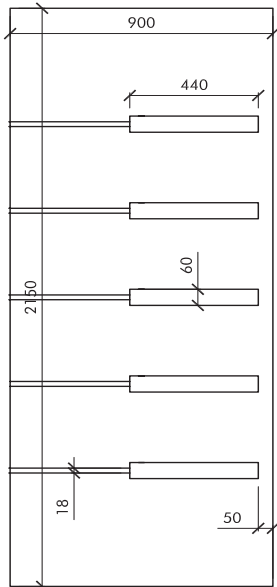

Gava 953

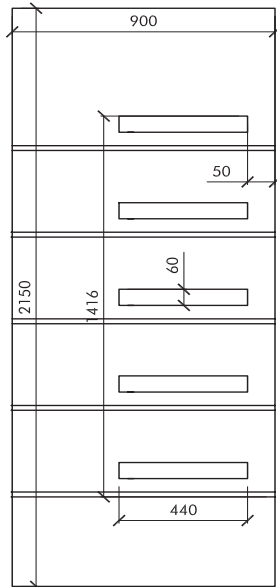

Gava 954

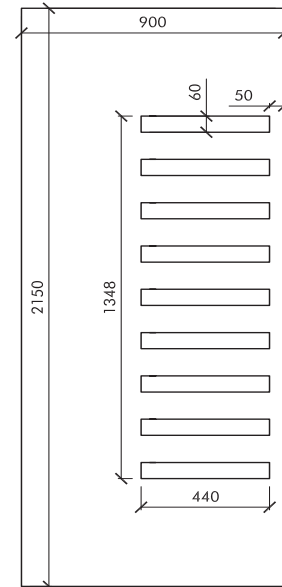

Gava 955

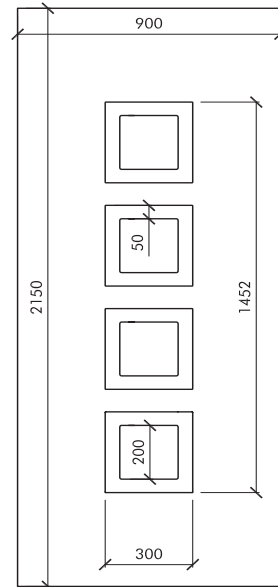

Gava 961a

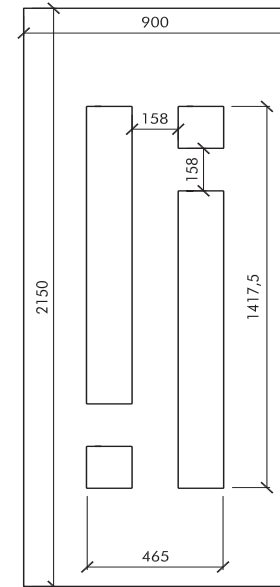

Gava 964

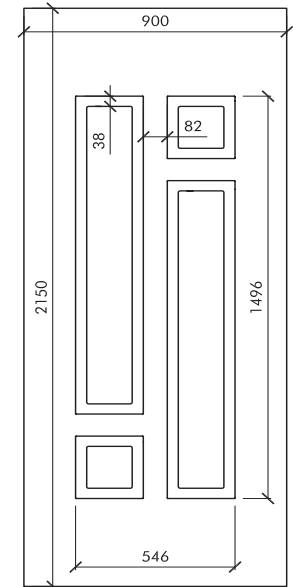

Gava 964q

# GAVA plast

# GAVA aluminium

CLASSIC

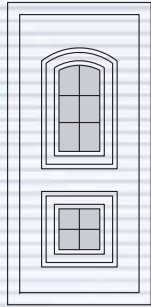

GAVA 010

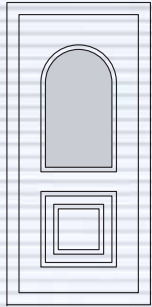

GAVA 020

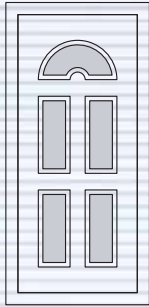

GAVA 030

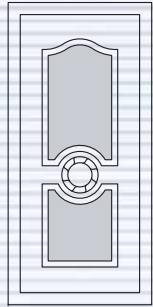

GAVA 040

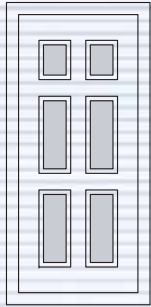

GAVA 060

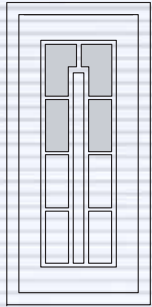

GAVA 280

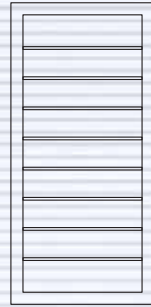

GAVA 400

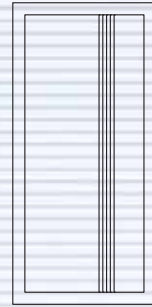

GAVA 401

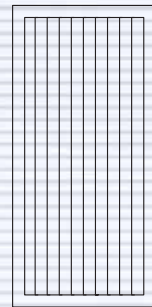

GAVA 402



GAVA 403

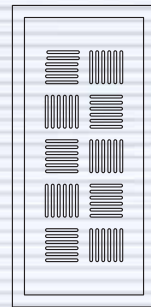

GAVA 404

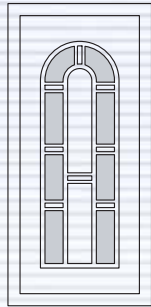

GAVA 070

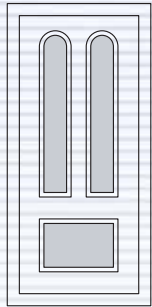

GAVA 080

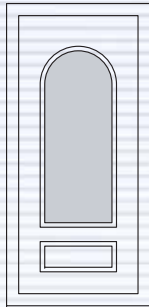

GAVA 240

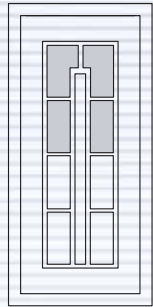

GAVA 280

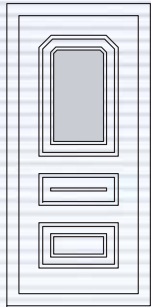

GAVA 250

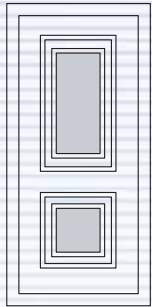

GAVA 220

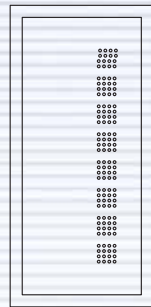

GAVA 405

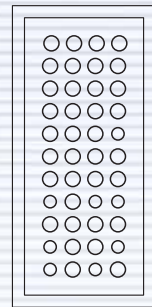

GAVA 406

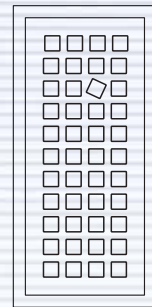

GAVA 407

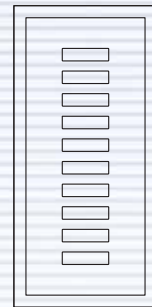

GAVA 408

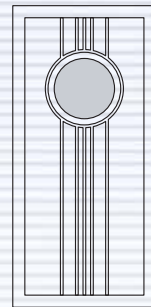

GAVA 409

MODERN

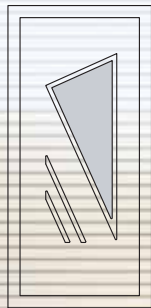

GAVA 090

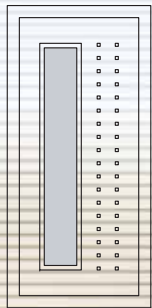

GAVA 260

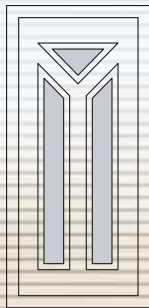

GAVA 050

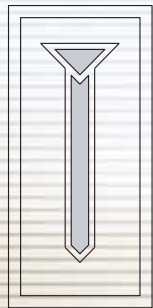

GAVA 230

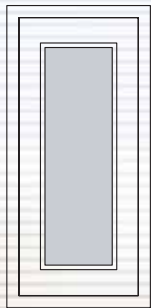

GAVA 100

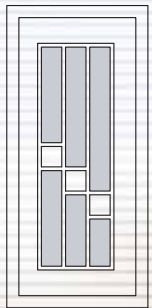

GAVA 130

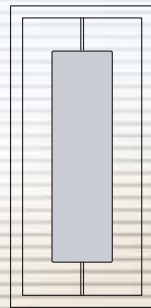

GAVA 410

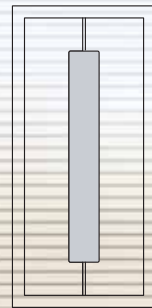

GAVA 411

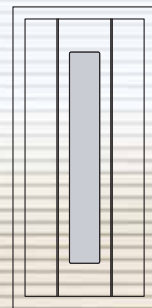

GAVA 412

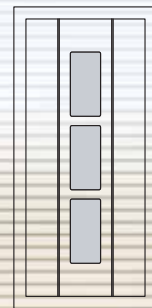

GAVA 413

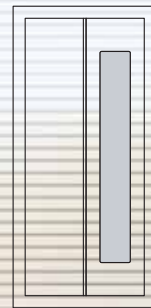

GAVA 414

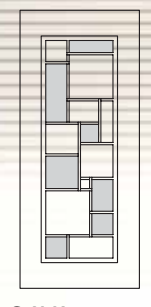

GAVA 140

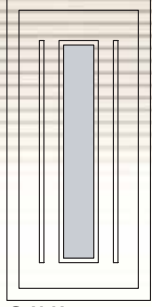

GAVA 150

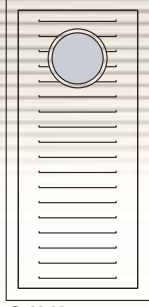

GAVA 200



GAVA 210

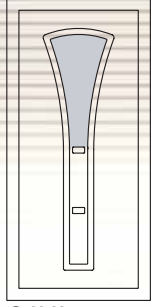

GAVA 270

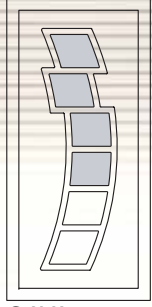

GAVA 290

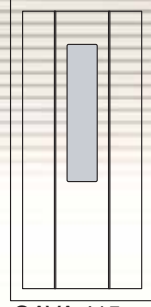

GAVA 415

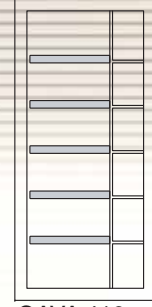

GAVA 416

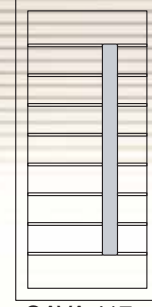

GAVA 417

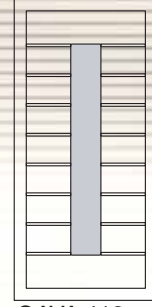

GAVA 418

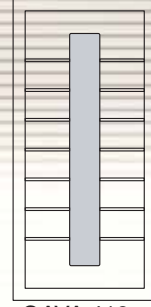

GAVA 419

# GAVA aluminium

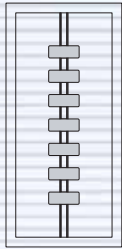

GAVA 420

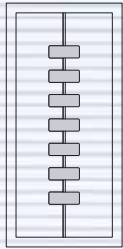

GAVA 421

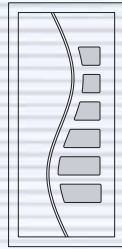

GAVA 430

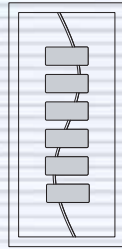

GAVA 431

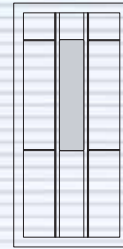

GAVA 440



GAVA 441

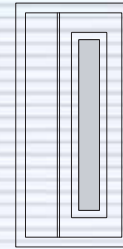

GAVA 450



GAVA 451

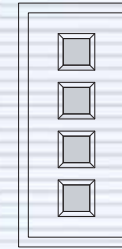

GAVA 460

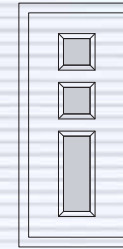

GAVA 461



GAVA 470



GAVA 471

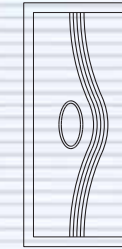

GAVA 480

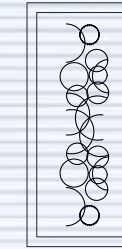

GAVA 481

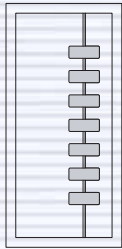

GAVA 422

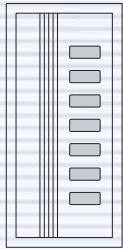

GAVA 423

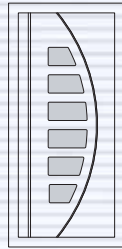

GAVA 432

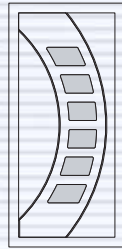

GAVA 433

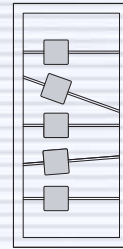

GAVA 442

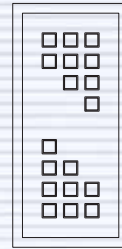

GAVA 443

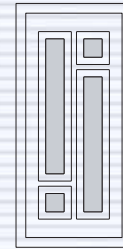

GAVA 452

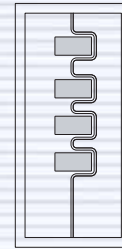

GAVA 453

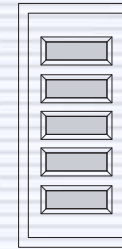

GAVA 462

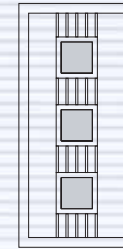

GAVA 463

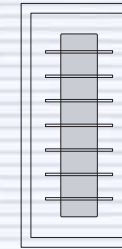

GAVA 472



GAVA 473

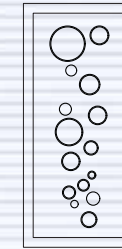

GAVA 482

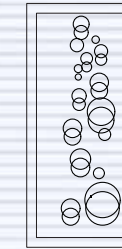

GAVA 483



GAVA 424



GAVA 425

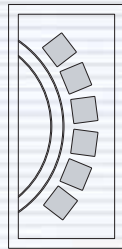

GAVA 434

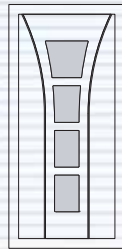

GAVA 435

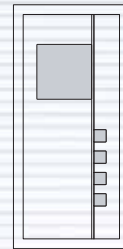

GAVA 444

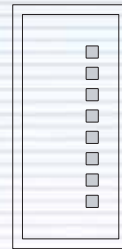

GAVA 445

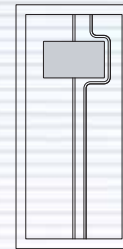

GAVA 454

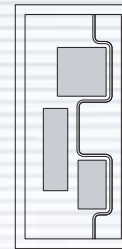

GAVA 455

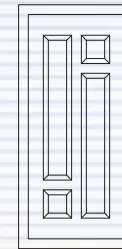

GAVA 464

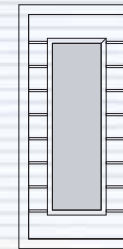

GAVA 465

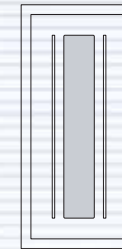

GAVA 474

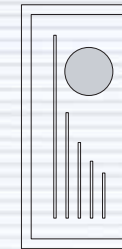

GAVA 475

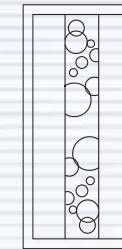

GAVA 484

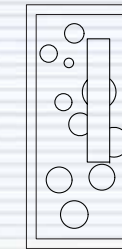

GAVA 485

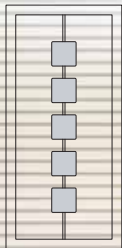

GAVA 426

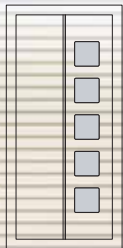

GAVA 427

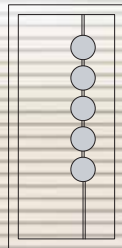

GAVA 436

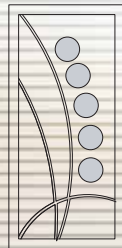

GAVA 437

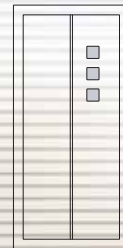

GAVA 446

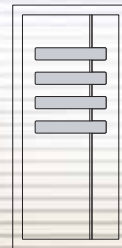

GAVA 447

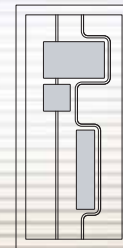

GAVA 456

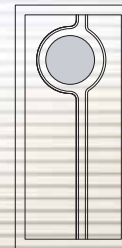

GAVA 457



GAVA 466

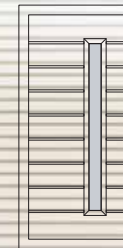

GAVA 467

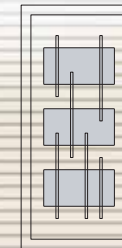

GAVA 476

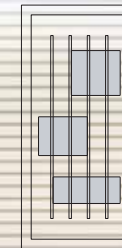

GAVA 477



GAVA 486



GAVA 487

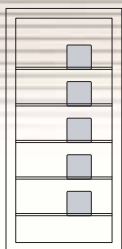

GAVA 428

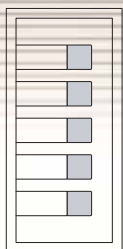

GAVA 429

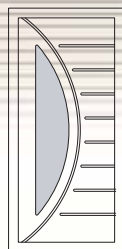

GAVA 438

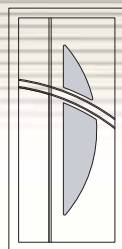

GAVA 439

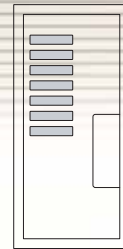

GAVA 448



GAVA 449

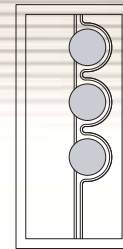

GAVA 458

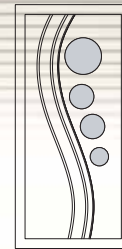

GAVA 459

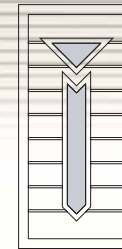

GAVA 468

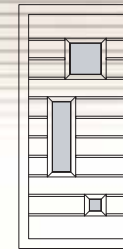

GAVA 469

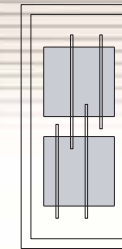

GAVA 478

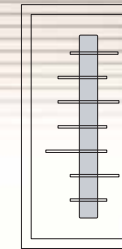

GAVA 479

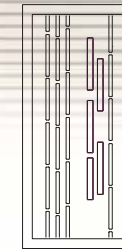

GAVA 488

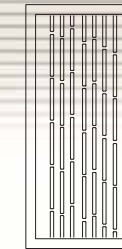

GAVA 489

## GAVA HPL

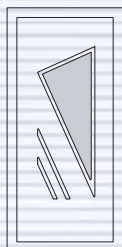

GAVA 690



GAVA 860

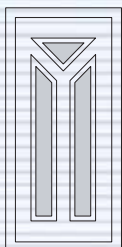

GAVA 650

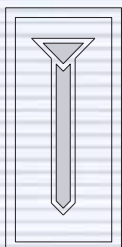

GAVA 830

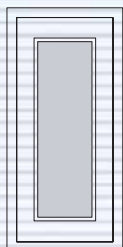

GAVA 700

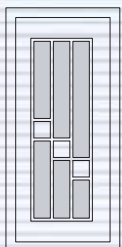

GAVA 730

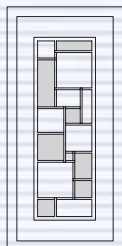

GAVA 740



GAVA 750

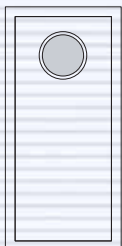

GAVA 800

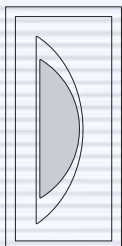

GAVA 810

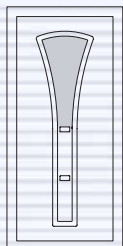

GAVA 870

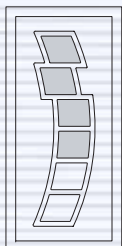

GAVA 890

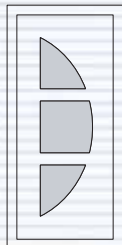

GAVA 939

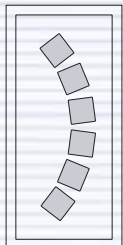

GAVA 941

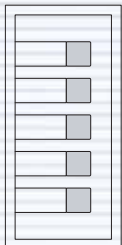

GAVA 929

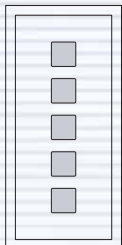

GAVA 926



GAVA 960

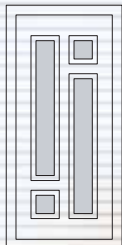

GAVA 964



GAVA 916

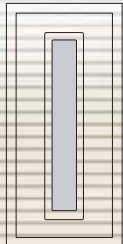

GAVA 912

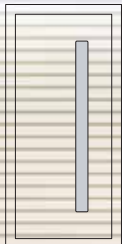

GAVA 917

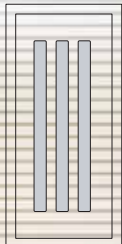

GAVA 918

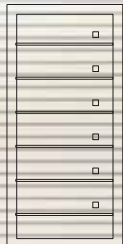

GAVA 900

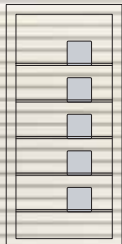

GAVA 928

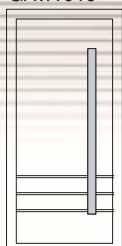

GAVA 919

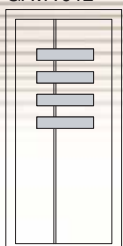

GAVA 948

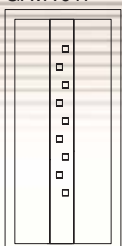

GAVA 950

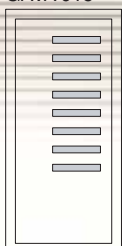

GAVA 951

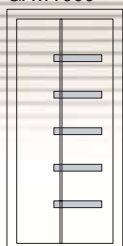

GAVA 952

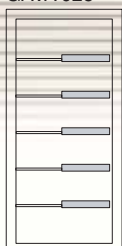

GAVA 953

## TARTALOMJEGYZÉK / TABLE OF CONTENTS

### **GAVApplast CLASSIC**

**3-19**

GAVA 010 , 020, 030, 040, 060,

GAVA 070, 080, 240, 250, 280

### **GAVApplast MODERN**

**20-42**

GAVA 050, 090, 260, 230

GAVA 100, 120, 130, 140, 150 - 180

GAVA 200, 210, 220, 270, 290

**GAVApplast PVC színválaszték/  
GAVApplast PVC colors**

### **GAVA aluminium**

**43-70**

GAVA 400 - 470

GAVA 480 - újdonság

**GAVAaluminium színválaszték/  
GAVAaluminium colors**

### **GAVA HPL**

**71-92**

GAVA 600 - 990

**GAVA hpl INTARZIA**

**GAVA hpl színválaszték /  
GAVA HPL colors**

### **kiegészítők/ accessories**

**93-96**

kopogtatók, levélbedobók, kitekintők, homokfúvott és  
katedrál üvegek / doorknockers, letter plates, optical  
door viewers, sand glasses and ornamental glasses

### **technikai adatok/ technical data**

**97-107**

panelek méretei / panel Size



az ötlettől **...a részletekig**

**Finesa Plusz Kft.**

✉ 1107 Budapest,  
Balkán utca 1/E  
☎ 06-1-371-1990  
📠 06-1-371-1991  
@ finesa@finesa.hu  
www.finesa.hu

*From sketch*  
**...to detail**

Az Ön forgalmazója / Your distributor:

[www.gavaplast.sk](http://www.gavaplast.sk)